

Energía

Interruptores caja moldeada MCCB	7-2 / 7-6
Especificaciones técnicas interruptores caja moldeada	7-7 / 7-8
Interruptores caja moldeada MCCB	7-9
Interruptores abiertos acb HGS y HGN	7-10
Especificaciones técnicas interruptores abiertos serie HGS	7-11
Mini interruptores MCB	7-12 / 7-13
Interruptores diferenciales RCB	7-14
Mini interruptores MCB	7-15 / 7-17
Especificaciones técnicas mini interruptores MCB	7-18 / 7-20
Guardamotores MMS	7-21
Contactores MC	7-22 / 7-23
Contactores auxiliares y accesorios	7-24
Accesorios para contactores MC	7-25
Especificaciones técnicas contactores MC	7-26 / 7-29
Relés térmicos TOR	7-30



INGRESA A

www.laumayer.com

PARA CONOCER DETALLES

INTERRUPTORES CAJA MOLDEADA MCCB

CÓDIGO	REFERENCIA	DESCRIPCIÓN				PRECIO UNITARIO
--------	------------	-------------	--	--	--	-----------------

INTERRUPTORES FIJOS HGM 100/800.... DE 16 A 800A

		Rango de Corriente (A)		Capacidad de Ruptura (KA)		Dimensiones A x L x P (mm)		
		In (A)	Ir (A)	220V AC	440V AC			
	HYU0295	HGM100 E3PT4S0000C 00016	16	-	35	16	75 x 130 x 68	\$ 251.600
	HYU0296	HGM100 E3PT4S0000C 00020	20	-	35	16	75 x 130 x 68	\$ 251.600
	HYU0297	HGM100 E3PT4S0000C 00025	25	-	35	16	75 x 130 x 68	\$ 259.500
	HYU0298	HGM100 E3PT4S0000C 00032	32	-	35	16	75 x 130 x 68	\$ 259.500
	HYU0299	HGM100 E3PT4S0000C 00040	40	-	35	16	75 x 130 x 68	\$ 259.500
	HYU0300	HGM100 E3PT4S0000C 00050	50	-	35	16	75 x 130 x 68	\$ 259.500
	HYU0301	HGM100 E3PT4S0000C 00063	63	-	35	16	75 x 130 x 68	\$ 259.500
	HYU0302	HGM100 E3PT4S0000C 00080	80	-	35	16	75 x 130 x 68	\$ 272.200
	HYU0303	HGM100 E3PT4S0000C 00100	100	-	35	16	75 x 130 x 68	\$ 286.300
NU	HYU0389	HGM250 E3PT4S0000C 00125	125	-	50	20	105 x 165 x 68	\$ 538.500
NU	HYU0390	HGM250 E3PT4S0000C 00160	160	-	50	20	105 x 165 x 68	\$ 547.100
NU	HYU0391	HGM250 E3PT4S0000C 00200	200	-	50	20	105 x 165 x 68	\$ 584.900
NU	HYU0392	HGM250 E3PT4S0000C 00250	250	-	50	20	105 x 165 x 68	\$ 605.800
NU	HYU0393	HGM400 E3PT4S0000C 00300	300	-	50	38	140 x 257 x 110	\$ 1.220.800
NU	HYU0394	HGM400 E3PT4S0000C 00400	400	-	50	38	140 x 257 x 110	\$ 1.260.900
NU	HYU0395	HGM630 E3PT4S0000C 00500	500	-	50	38	210 x 280 x 110	\$ 1.940.400
NU	HYU0396	HGM630 E3PT4S0000C 00630	630	-	50	38	210 x 280 x 110	\$ 2.004.000
NU	HYU0397	HGM800 S3PT4S0000C 00800	800	-	75	50	210 x 280 x 110	\$ 2.765.100



HGM100-800
Ics=100% Icu

INTERRUPTORES REGULABLES HGM 100 S3PT4S....F DE 16 A 800A, 50KA/220VAC

		Rango de Corriente (A)		Capacidad de Ruptura (KA)		Dimensiones A x L x P (mm)		
		In (A)	Ir (A)	220V AC	440V AC			
	HYU0304	HGM100 S3PT4S0000C 00016F	16	13 ~ 16	50	20	75 x 130 x 68	\$ 317.900
	HYU0305	HGM100 S3PT4S0000C 00020F	20	16 ~ 20	50	20	75 x 130 x 68	\$ 317.900
	HYU0306	HGM100 S3PT4S0000C 00025F	25	20 ~ 25	50	20	75 x 130 x 68	\$ 328.100
	HYU0307	HGM100 S3PT4S0000C 00032F	32	26 ~ 32	50	20	75 x 130 x 68	\$ 328.100
	HYU0308	HGM100 S3PT4S0000C 00040F	40	32 ~ 40	50	20	75 x 130 x 68	\$ 328.100
	HYU0309	HGM100 S3PT4S0000C 00050F	50	40 ~ 50	50	20	75 x 130 x 68	\$ 328.100
	HYU0310	HGM100 S3PT4S0000C 00063F	63	51 ~ 63	50	20	75 x 130 x 68	\$ 328.100
	HYU0311	HGM100 S3PT4S0000C 00080F	80	64 ~ 80	50	20	75 x 130 x 68	\$ 328.100
	HYU0312	HGM100 S3PT4S0000C 00100F	100	80 ~ 100	50	20	75 x 130 x 68	\$ 356.900
	HYU0313	HGM250 E3PT4S0000C 00125F	125	100 ~ 125	50	20	105 x 165 x 68	\$ 652.500
	HYU0314	HGM250 E3PT4S0000C 00160F	160	128 ~ 160	50	20	105 x 165 x 68	\$ 663.900
	HYU0315	HGM250 E3PT4S0000C 00200F	200	160 ~ 200	50	20	105 x 165 x 68	\$ 714.100
	HYU0316	HGM250 E3PT4S0000C 00250F	250	200 ~ 250	50	20	105 x 165 x 68	\$ 734.900
	HYU0317	HGM400 E3PT4S0000C 00300F	300	189 ~ 300	50	38	140 x 257 x 110	\$ 1.488.900
	HYU0318	HGM400 E3PT4S0000C 00400F	400	252 ~ 400	50	38	140 x 257 x 110	\$ 1.528.100
	HYU0319	HGM630 E3PT4S0000C 00500F	500	315 ~ 500	50	38	210 x 280 x 110	\$ 2.419.400
	HYU0320	HGM630 E3PT4S0000C 00630F	630	397 ~ 630	50	38	210 x 280 x 110	\$ 2.502.900
	HYU0336	HGM800 H3PT4S0000C 00800F	800	504 ~ 800	100	70	210 x 280 x 110	\$ 3.445.600



HGM400

INTERRUPTORES CAJA MOLDEADA MCCB

| Extension handle (THA) |

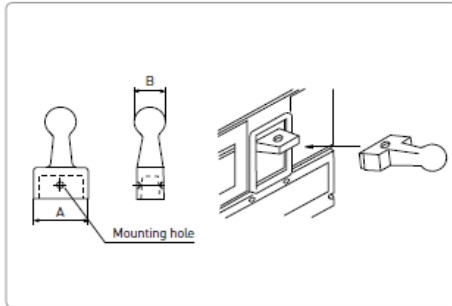

AUX 80NE R2
ALT 80NE R1

Bloqueo para hasta 3 candados
Ampliacion de maneta
enclavamiento mecanico

Parece que no hay maneta a puerta
incuir motorizado
Bobina de apertura

2 contactor
1 contacto

| Padlock plate (PLD) |

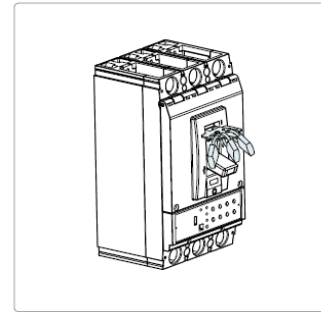

PLD 120NE
THA 120NE

Model		HMB1000	HMB1250	HMB1600
Frame	MM	1,000	1,250	1,600
Pole	PF	3.1"	3.1"	3
Rated current, at 40°C, Electric	MA	1,000	1,000(1,250)	1,600
Rated short-circuit breaking capacity (kA) (kA) (kA) (kA)	Resegriten mode for arctic	5	5	5
	AC440V/50V	25	25	25
	AC440V/60V	45	45	45
	AC380V/50V	30	30	30
	AC380V/60V	50	50	50
Rated breaking capacity (kA) (kA) (kA) (kA)	AC660V/50V	12.5	12.5	12.5
	AC660V/60V	17.5	17.5	17.5
	AC440V/50V	22.5	22.5	22.5
	AC380V/50V	45	45	45
	AC380V/60V	50	50	50
Rated short-time withstand current (kA) (kA) (kA)	ts	7s	1s	120%
Insulation (Durability)	Mechanical	10,000	10,000	10,000
	Electrical	5,000	3,000	5,000
Tripping Device		●	●	●
Electronic	Long time (S, L)	0.4 0.5 0.6 0.7 0.8 0.9 0.95 1.0s	0.4 0.5 0.6 0.7 0.8 0.9 0.95 1.0s	0.4 0.5 0.6 0.7 0.8 0.9 0.95 1.0s
	Short time (S70, L)	2-3-4-5-6-7-8-10x	1-2-4-5-6-7-8-10x	2-3-4-5-6-7-8-10x
	Instantaneous (SNGE, L)	2-3-4-5-6-7-8-10x	2-3-4-5-6-7-8-10x	2-3-4-5-6-7-8-10x
Accessory	Auxiliary switch	AUX	●	●
	Alarm switch	ALT	●	●
	Short trip	SHI	●	●
	Under-voltage trip	UVT	●	●
	Rotary handle	Rotated TRH	●	●
	Motor operator	MOT	●	●
	Mechanical interlock	MI	●	●
	Lock Mechanism with Key		●	●
	Shunt out		●	●
	External	Plug-in	TOMLINE/LOAD	-
		TOMLINE Only	-	-
Cage terminal block		CTB	●	●
Insulation terminal cover		TCI	●	●
Insulation barrier		IBB	Standard	Standard
Terminal extensions		TBB	Standard	Standard
Installation and dimensions	Front connection	Terminal busbar	Terminal busbar	Terminal busbar
	Rear connection	-	-	-
	Plug-in	-	-	-
Dimensions (mm)	a (H&P)	210(220)	210(220)	270
	b	370	298	370
	c	124	126	160

INTERRUPTORES CAJA MOLDEADA MCCB

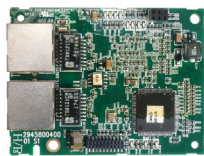

CMC-PN01

CÓDIGO	REFERENCIA	DESCRIPCIÓN	PRECIO UNITARIO
--------	------------	-------------	-----------------

INTERRUPTORES REGULABLES HGM125H3PT4S...F DE 16 a 250A, 85KA/220VAC Y 400 a 800A, 100KA/220VAC

			Rango de Corriente (A)		Capacidad de Ruptura (KA)		Dimensiones A x L x P (mm)	
			In (A)	I _r (A)	220V AC	440V AC		
*	HYU0321	HGM125 H3PT4S0000C 00016F	16	13 ~ 16	85	38	90 x 155 x 68	\$ 518.400
*	HYU0322	HGM125 H3PT4S0000C 00020F	20	16 ~ 20	85	38	90 x 155 x 68	\$ 527.900
*	HYU0323	HGM125 H3PT4S0000C 00025F	25	20 ~ 25	85	38	90 x 155 x 68	\$ 537.700
*	HYU0324	HGM125 H3PT4S0000C 00032F	32	26 ~ 32	85	38	90 x 155 x 68	\$ 547.800
*	HYU0325	HGM125 H3PT4S0000C 00040F	40	32 ~ 40	85	38	90 x 155 x 68	\$ 558.300
*	HYU0326	HGM125 H3PT4S0000C 00050F	50	40 ~ 50	85	38	90 x 155 x 68	\$ 569.300
*	HYU0327	HGM125 H3PT4S0000C 00063F	63	51 ~ 63	85	38	90 x 155 x 68	\$ 580.700
*	HYU0328	HGM125 H3PT4S0000C 00080F	80	64 ~ 80	85	38	90 x 155 x 68	\$ 592.500
*	HYU0329	HGM125 H3PT4S0000C 00100F	100	80 ~ 100	85	38	90 x 155 x 68	\$ 604.900
*	HYU0330	HGM125 H3PT4S0000C 00125F	125	100 ~ 125	85	38	90 x 155 x 68	\$ 617.700
*	HYU0331	HGM250 H3PT4S0000C 00160F	160	128 ~ 160	85	38	105 x 165 x 68	\$ 1.043.000
*	HYU0332	HGM250 H3PT4S0000C 00200F	200	160 ~ 200	85	38	105 x 165 x 68	\$ 1.564.400
*	HYU0333	HGM250 H3PT4S0000C 00250F	250	200 ~ 250	85	38	105 x 165 x 68	\$ 1.752.200
*	HYU0334	HGM400 H3PT4S0000C 00400F	400	252 ~ 400	100	70	140 x 257 x 110	\$ 2.340.600
*	HYU0335	HGM630 H3PT4S0000C 00630F	630	397 ~ 630	100	70	210 x 280 x 110	\$ 3.279.000
*	HYU0336	HGM800 H3PT4S0000C 00800F	800	504 ~ 800	100	70	210 x 280 x 110	\$ 3.445.600



TFH

MANIJAS				
NU	HYU0337	TFH 10GM	Manija a puerta para HGM100	\$ 219.900
NU	HYU0338	TFH 12GM	Manija a puerta para HGM125	\$ 219.900
NU	HYU0339	TFH 25GM	Manija a puerta para HGM250	\$ 227.700
NU	HYU0340	TFH 40GM	Manija a puerta para HGM400	\$ 578.800
NU	HYU0341	TFH 80GM	Manija a puerta para HGM630,800	\$ 594.200
NU	HYU0377	THA48GM	Maneta o lengüeta auxiliar para HGM400-800	\$ 56.400
NU	HYU0342	TFG 10GMU	Manija para montaje sobre interruptor para HGM100	\$ 140.900
NU	HYU0343	TFG 12GMU	Manija para montaje sobre interruptor para HGM125	\$ 140.900
NU	HYU0344	TFG 25GMU	Manija para montaje sobre interruptor para HGM250	\$ 155.600
NU	HYU0345	TFG 40GMU	Manija para montaje sobre interruptor para HGM400	\$ 473.100
NU	HYU0346	TFG 80GMU	Manija para montaje sobre interruptor para HGM630,800	\$ 540.200
NU	HYU0375	PLD 10GM	Accesorio de manija (a puerta o sobre int.) Para candado usar con hgm100 ~ 250 , diametro candado 5mm soporta hasta 3 candados	\$ 64.000
NU	HYU0376	PLD 40GM	Accesorio de manija (a puerta o sobre int.) Para candado usar con hgm400 ~ 800 , diametro candado 5mm soporta hasta 3 candados	\$ 64.000

CONTACTOS AUXILIARES				
	HYU0347	AUX 10GMC1	Contacto auxiliar para hgm100-250	\$ 44.100
NU	HYU0497	ALT10GMR1	Contacto aux. Falla (alarma) alt10gmr1 para hgm100-250	\$ 71.700
NU	HYU0498	ALT40GML1	Contacto aux. Falla (alarma) alt40gml1 para hgm400-800	\$ 83.700
	HYU0348	AUX 40GMC1	Contacto auxiliar para hgm400-800	\$ 73.200

INTERRUPTORES CAJA MOLDEADA MCCB

CÓDIGO	REFERENCIA	DESCRIPCIÓN	PRECIO UNITARIO
--------	------------	-------------	-----------------

BOBINAS DE MÍNIMA Y DISPARO

		TIPO DE BOBINA	VOLTAJE	PARA INTERRUPTOR		
*	HYU0349	UVT10 GM DC24V	Mínima Tensión	24V DC	HGM100-250	\$ 419.700
*	HYU0350	UVT40 GM DC24V	Mínima Tensión	24V DC	HGM400-800	\$ 419.700
*	HYU0351	UVT10 GM AC100-120V	Mínima Tensión	100-120V AC	HGM100-250	\$ 273.500
*	HYU0352	UVT40 GM AC100-120V	Mínima Tensión	100-120V AC	HGM400-800	\$ 273.500
	HYU0353	UVT10 GM AC200-230V	Mínima Tensión	200-230V AC	HGM100-250	\$ 273.500
	HYU0354	UVT40 GM AC200-230V	Mínima Tensión	200-230V AC	HGM400-800	\$ 273.500
*	HYU0355	SHT10 GM DC24V	Disparo o Shunt	24V DC	HGM100-250	\$ 187.900
*	HYU0356	SHT40 GM DC24V	Disparo o Shunt	24V DC	HGM400-800	\$ 438.800
*	HYU0357	SHT10 GM AC100-120V	Disparo o Shunt	100-120V AC	HGM100-250	\$ 93.600
*	HYU0358	SHT40 GM AC100-120V	Disparo o Shunt	100-120V AC	HGM400-800	\$ 212.400
	HYU0359	SHT10 GM AC200-250V	Disparo o Shunt	200-230V AC	HGM100-250	\$ 93.600
	HYU0360	SHT40 GM AC200-230V	Disparo o Shunt	200-230V AC	HGM400-800	\$ 212.400

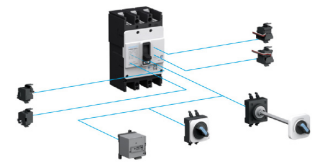

ENCLAVAMIENTO MECÁNICO (PARA USO SIN MOTORIZADO)

		PARA INTERRUPTOR	
HYU0361	MIF 10GM 3	HGM100	\$ 109.000
HYU0362	MIF 12GM 3	HGM125	\$ 109.000
HYU0363	MIF 25GM 3	HGM250	\$ 125.800
HYU0364	MIF 40GM 3	HGM400	\$ 196.000
HYU0365	MIF 80GM 3	HGM630,800	\$ 227.500

Internal Accessories (HGM)

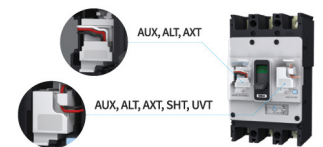

OPERADOR MOTORIZADO

		VOLTAJE	PARA INTERRUPTOR		
*	HYU0366	MOT25 GM DC24V	24V DC	HGM250	\$ 2.024.400
*	HYU0367	MOT40 GM DC24V	24V DC	HGM400	\$ 2.907.900
*	HYU0368	MOT80 GM DC24V	24V DC	HGM630,800	\$ 3.271.000
*	HYU0369	MOT25 GM AC/DC110V	110V AC/DC	HGM250	\$ 2.024.400
*	HYU0370	MOT40 GM AC/DC110V	110V AC/DC	HGM400	\$ 2.907.900
*	HYU0371	MOT80 GM AC/DC110V	110V AC/DC	HGM630,800	\$ 3.271.000
	HYU0372	MOT25 GM AC/DC240V	240V AC/DC	HGM250	\$ 2.024.400
	HYU0373	MOT40 GM AC/DC240V	240V AC/DC	HGM400	\$ 2.907.900
	HYU0374	MOT80 GM AC/DC240V	240V AC/DC	HGM630,800	\$ 3.271.000

* Producto bajo pedido

** Producto última vez en lista de precios o hasta agotar inventarios

NU Producto Nuevo

INTERRUPTORES CAJA MOLDEADA MCCB

CÓDIGO	REFERENCIA	DESCRIPCIÓN	PRECIO UNITARIO
JUEGOS DE TERMINALES Y CUBIERTAS			
* HYU0378	CTB10 GM 3S50	Juego de terminales 3P menor 50A 2.5-16MM HGM100	\$ 68.300
* HYU0379	CTB10 GM 3S100	Juego de terminales 3P mayor 50A 16-50MM HGM100	\$ 68.300
* HYU0380	CTB12 GM 3S	Juego de terminales 3 polos 2.5-70MM HGM125	\$ 68.300
* HYU0381	CTB25 GM 3S	Juego de terminales 3 polos 50-180MM HGM160,250	\$ 68.300
* HYU0382	CTB40 GM 3S	Juego de terminales 3 polos 60-240MM HGM400	\$ 386.700
* HYU0383	CTB80 GM 3S	Juego de terminales 3 polos 60-185MM HGM630,800	\$ 613.100
HYU0384	TCF10 GM S3	Cubierta de terminales IP40 corta 3P HGM100	\$ 24.100
HYU0385	TCF12 GM S3	Cubierta de terminales IP40 corta 3P HGM125	\$ 24.900
HYU0386	TCF25 GM S3	Cubierta de terminales IP40 corta 3P HGM160,250	\$ 27.900
HYU0387	TCF40 GM S3	Cubierta de terminales IP40 corta 3P HGM400	\$ 49.400
HYU0388	TCF80 GM S3	Cubierta de terminales IP40 corta 3P HGM630,800	\$ 54.300

INTERRUPTOR	ANCHO	ALTO	PROF
HGM100	75	130	68
HGM125	90	155	68
HGM250	105	165	68
HGM400	140	257	110
HGM630	210	280	110
HGM800	210	280	110

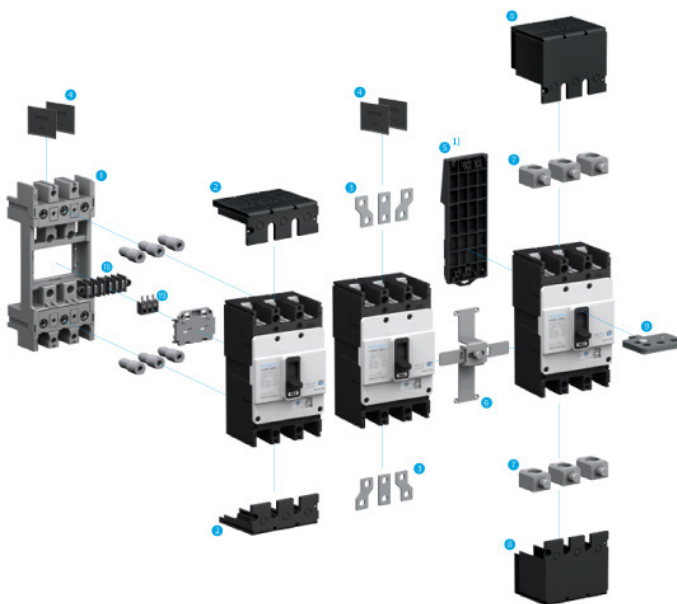

* Producto bajo pedido

** Producto última vez en lista de precios o hasta agotar inventarios

NU Producto Nuevo

ESPECIFICACIONES TÉCNICAS

INTERRUPTORES CAJA MOLDEADA MCCB



Modelo		HGM100			HGM250			
Marco	(AF)		100			250		
Polos	(P)		3			3		
Corriente nominal, a 40°	(A)		20, 25, 32, 40, 50, 63, 75, 80, 100			100, 125, 150, 160, 175, 200, 225, 250		
Poder de corte [Icu] (kA rms)	Código para pedido		E	S	H	E	S	H
	AC660/690 V		2.5	5	7.5	7.5	8	8
	AC480/500 V		7.5	10	14	14	20	26
	AC440/460 V		16	20	26	20	26	38
	AC380/415 V		16	20	26	20	26	38
	AC220/240 V		35	50	50	50	65	85
	DC250 V (2P)		5	10	15	10	15	20
Capac. de corte del servicio [Ics = 100% Icu]			100	100	75	100	100	100
Endurancia (maniobras)	Mecánica		30000			30000		
	Eléctrica		10000			10000		
Protección Magnética	Fija		(1.0) x In			(1.0) x In		
	Ajustable		(0.8 - 0.9 - 1.0) x In			(0.8 - 0.9 - 1.0) x In		
	Instantáneo [INST]		16 - 32 A: 400 A, 40 - 100 A: 10 x In			10 x In		
Accesorios								
Internos	Contacto auxiliar	AUX	si	si	si	si	si	si
	Señalización alarma	ALT	si	si	si	si	si	si
	Bobina de emisión	SHT	si	si	si	si	si	si
	Bobina de mínima tensión	UVT	si	si	si	si	si	si
Externos	Manija Sobre interruptor	TFG	si	si	si	si	si	si
	Manija a puerta	TFH	si	si	si	si	si	si
	Mando motorizado	MOT	si	si	si	si	si	si
	Enclavamiento mecánico	MIF	si	si	si	si	si	si
	Bloqueo candado	PLD	si	si	si	si	si	si
	Bloque prensacables	CTB	si	si	si	si	si	si
	Cubrebornes	TCF	si	si	si	si	si	si
	Separador de fases	TQQ	si	si	si	si	si	si
Pletina espaciadora	TBB				si	si	si	
Instalación y dimensiones								
Conexión	Conexión frontal		Terminal de tornillo			Terminal de tornillo/pala		
Dimensiones (mm)	a (2/3/4P)		75			105		
	b		130			165		
	c		68			68		
Peso (kg)	2/3/4P		0.6/0.8/1.0			1.1/1.3/1.7		

ESPECIFICACIONES TÉCNICAS

INTERRUPTORES CAJA MOLDEADA MCCB

Modelo		HGM400			HGM630			HGM800		
Marco	(AF)	400			630			800		
Polos	(P)	3			3			3		
Corriente nominal, a 40°	(A)	250, 300, 350, 400			500, 630			700, 800		
Poder de corte [Icu] (kA rms)	Código para pedido	E	S	H	E	S	H	S	H	
	AC660/690 V	5	8	10	5	8	10	8	10	
	AC480/500 V	18	35	50	25	45	50	45	50	
	AC440/460 V	38	50	70	38	50	70	50	70	
	AC380/415 V	45	65	85	45	65	85	65	85	
	AC220/240 V	50	75	100	50	75	100	75	100	
	DC250 V (2P)	20	25	40	20	25	40	25	40	
Capac. de corte del servicio [Ics = 100% Icu]		100	100	100	100	100	100	100	100	
Endurancia (maniobras)	Mecánica	30000			30000			30000		
	Eléctrica	10000			10000			10000		
Protección Magnética	Fija	(1.0) x In			(1.0) x In			(1.0) x In		
	Ajustable	(0.63 - 0.8 - 1.0) x In			(0.63 - 0.8 - 1.0) x In			(0.63 - 0.8 - 1.0) x In		
	Instantáneo [INST]	10 x In			10 x In			10 x In		
Accesorios										
Internos	Contacto auxiliar	AUX	si	si	si	si	si	si	si	si
	Señalización alarma	ALT	si	si	si	si	si	si	si	si
	Bobina de emisión	SHT	si	si	si	si	si	si	si	si
	Bobina de mínima tensión	UVT	si	si	si	si	si	si	si	si
Externos	Manija Sobre interruptor	TFG	si	si	si	si	si	si	si	si
	Manija a puerta	TFH	si	si	si	si	si	si	si	si
	Mando motorizado	MOT	si	si	si	si	si	si	si	si
	Enclavamiento mecánico	MIF	si	si	si	si	si	si	si	si
	Bloqueo candado	PLD	si	si	si	si	si	si	si	si
	Bloque prensacables	CTB	si	si	si	si	si	si	si	si
	Cubrebornes	TCF	si	si	si	si	si	si	si	si
	Separador de fases	TQQ	si	si	si	si	si	si	si	si
Pletina espaciadora	TBB	si	si	si	si	si	si	si	si	
Instalación y dimensiones										
Conexión	Conexión frontal	Terminal de tornillo			Terminal de tornillo/pala			Terminal de tornillo/pala		
Dimensiones (mm)	a (2/3/4P)	140			210			210		
	b	257			280			280		
	c	110			110			110		
Peso (kg)	2/3/4P	4/4.5/5.4			8.7/9.5/12.5			8.7/9.5/12.5		

INTERRUPTORES CAJA MOLDEADA Mccb



CÓDIGO	REFERENCIA	DESCRIPCIÓN	PRECIO UNITARIO
--------	------------	-------------	-----------------

INTERRUPTORES CAJA MOLDEADA DE 1000A HASTA 1600A, Electronicos, LSI								
		Rango de Corriente (A)			"Capacidad de Ruptura (KA)"		"Dimensiones A x L x P (mm)"	
		In (A)	"Ir (A) Min."	"Ir (A) Max"	220V AC	440V AC		
HYU0600	HGM1000S3PENBS-0000C01000A	1000	400	1000	100KA	45KA	210x370x124	\$12.063.000
HYU0601	HGM1250S3PENBS-0000C01250A	1250	500	1250	100KA	45KA	210x370x124	\$14.600.000
* HYU0602	HGM1600S3PENBS-0000C01600	1600	640	1600	100KA	45KA	210x370x155	\$22.400.000



ACCESORIOS			
		DESCRIPCIÓN	
* HYU0603	AUX120GMSC2	CONTACTO AUX. ESTADO AUX120GMSC2 PARA HGM1000-1600, 2NA-2NC	\$ 280.400
* HYU0604	ALT120GMSR1	CONTACTO AUX. FALLA (ALARMA) ALT120GMSR1 PARA HGM1000-1600	\$ 205.700
* HYU0605	AXT120GMS	CONTACTO AUX. AXT120GMS PARA HGM1000-1600	\$ 878.700
* HYU0606	SHT120GM-SAC200-230V	BOBINA SHT120GMSAC200-230V DE DISPARO 220V PARA HGM1000-1600	\$ 448.700
* HYU0607	UVT120GM-SAC200-230V	BOBINA UVT120GMSAC200-230V DE MINIMA 220V PARA HGM1000-1600	\$ 542.200
* HYU0608	MOT120GMS3-220-240V	MOTORIZADO MOT120GMS3-220-240V DE 220V PARA HGM1000-1600	\$ 7.646.900
* HYU0609	TFH120GMS3	MANIJA A PUERTA TFH120GMS3 PARA HGM1000-1600	\$ 1.252.700
* HYU0610	MIF120GMS3	ENCLAVAMIENTO MECANICO MIF120GMS3 PARA HGM1000-1600 (MANUAL)	\$ 3.028.800
* HYU0611	KEY120GMS	BLOQUEO INTERRUPTOR PARA CANDADO KEY120GMS PARA HGM1000-1600	\$ 243.100
* HYU0612	THA120GMS	MANETA AUXILIAR THA120GMS PARA HGM1000-1600	\$ 168.300
* HYU0613	TCF120GMS3	COBERTURA PARA TERMINALES TCF120GMS3 PARA HGM1000-1600	\$ 130.900
* HYU0614	TQQ120GMS3	BARRERA DE FASES TQQ120GMS3 PARA HGM1000-1600	\$ 37.400

* Producto bajo pedido

** Producto última vez en lista de precios o hasta agotar inventarios

NU Producto Nuevo

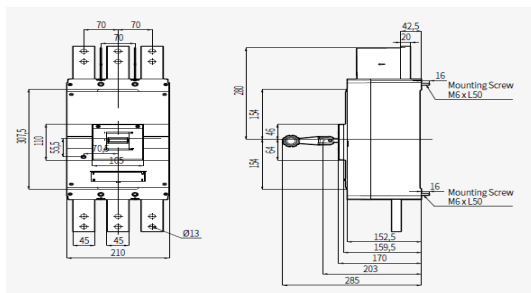

HGM1000S3PENBS0000C0XXA



HGM1000S3PENBS0000C0XXA



INTERRUPTORES ABIERTOS ACB HGS Y HGN



HGN

Ics=100% Icu



HGS

GPR-LA



- Protección sobrecarga (L/S/I/G)
- Auto alimentación
- Contacto de salida individual continuo
- Registro de fallos (hasta 256) y armónicos (4 ciclos, verificación vía comunicación)
- Comunicación (MODBUS), se puede utilizar conexión a tierra externa ZCT

CÓDIGO	REFERENCIA	DESCRIPCIÓN	PRECIO UNITARIO
--------	------------	-------------	-----------------

INTERRUPTORES ABIERTOS HGS MONTAJE FIJO DE 800-3200A, UNIDAD DE PROTECCIÓN GPR-LA (L/S/I/G) CON COMUNICACIÓN MODBUS

			Rango de Corriente (A)		Capacidad de Ruptura (KA)		FRAME	
			In (A)	Ir (A)	220V AC	500V AC		
*	HYU0398	HGS 08A3HMOC0S061H	800	320-800	65	65	A	\$ 11.926.500
NU	HYU0399	HGS 10A3HMOC0S061J	1000	400-1000	65	65	A	\$ 12.160.300
NU	HYU0400	HGS 12A3HMOC0S061K	1250	500-1250	65	65	A	\$ 12.316.200
	HYU0401	HGS16A3HMOC0S061L	1600	640-1600	65	65	A	\$ 12.500.000
	HYU0402	HGS20B3HMOC0S061M	2000	800-2000	85	85	B	\$ 15.937.800
	HYU0403	HGS25B3HMOC0S061N	2500	1000-2500	85	85	B	\$ 18.464.100
	HYU0404	HGS32B3HMOC0S061P	3200	1280-3200	85	85	B	\$ 19.355.400

ENCLAVAMIENTO MECÁNICO PARA INTERRUPTORES DE MONTAJE FIJO

PARA INTERRUPTOR: HGN/HGS			
HYU0428	HGNS FWB1A	PARA DOS INTERRUPTORES FRAME A	\$ 3.815.000
HYU0430	HGNS FWB1B	PARA DOS INTERRUPTORES FRAME B	\$ 4.099.100

BOBINAS DE ACCIONAMIENTO Y MOTORIZADO PARA INTERRUPTORES DE MONTAJE FIJO

		ELEMENTO	VOLTAJE	PARA INTERRUPTOR	
HYU0442	HGNS M2U	Motorizado	220V AC/DC	HGN / HGS	\$ 1.570.000
HYU0443	HGNS C2	Bobina Cierre	220V AC/DC	HGN / HGS	\$ 409.000
HYU0444	HGNS S2	Bobina Apertura / Disparo	220V AC/DC	HGN / HGS	\$ 409.000

CONTACTOS AUXILIARES DE ESTADO

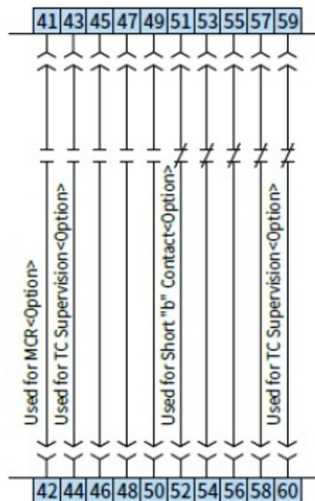

CONTACTOS AUXILIARES DE DISPARO O FALLA

Punt os de conexión	Co ntact os de falla
22 2 1	Sobr ecar ga
22 2 3	Pr edispar o (Sob r ecar ga)
22 24	Co rti cuit o e instantáne o
22 26	Fa lla a tierr a

* Producto bajo pedido
 ** Producto última vez en lista de precios o hasta agotar inventarios
 NU Producto Nuevo



ESPECIFICACIONES TÉCNICAS

INTERRUPTORES ABIERTOS SERIE HGS - ACB



Marco Tipo		A	B	A	
Corriente nominal [In max]	Temperatura basada en 40 °C A	06 : 630	20 : 2,000	06 : 630	
		08 : 800	25 : 2,500	08 : 800	
		10 : 1,000	32 : 3,200	10 : 1,000	
		12 : 1,250		12 : 1,250	
		16 : 1,600		16 : 1,600	
				20 : 2,000	
Tensión nominal de empleo [Ue]	V	690	690	690	
Tensión nominal de aislamiento [Ui]	V	1	1	1	
Frecuencia	Hz	50/60	50/60	50/60	
Número de Polos	P	3, 4	3, 4	3, 4	
Rango de regulación de intensidad (... x In max)	A	0.4 ~ 1.0	0.4 ~ 1.0	0.4 ~ 1.0	
Intensidad nominal del neutro (N) (... % x In) A	A	100%	100%	100%	
Poder de corte [Icu] [kA sym]					
IEC 60947- Categoría		690/600/550 V	50	70 1) (KS : 65)	65
"B"	AC	500/480/460 V KA	65	85	85
KS C 4620		415/380/230/220 V	65	85	85
Poder de corte de servicio [Ics] ... % x Icu			100%	100%	100%
Poder de cierre [Icm] [kA pico]					
IEC 60947- Categoría		690/600/550 V	105	154	143
"B"	AC	500/480/460 V KA	143	187	187
KS C 4620		415/380/230/220 V	143	187	187
Intensidad de corta duración admisible [Icw] (Sin Inst)					
1 Seg.			50	70	65
2 Seg.		KA	35	65	42
3 Seg.			28	50	35
Tensión asignada soportada al impulso [Uimp]		Kv	12	12	12
Tiempo máximo de corte		mS	40 3)	40 3)	40 3)
Tiempo de cierre					
Tiempo de rearme motor (seg) max.			10	10	10
Tiempo de cierre (ms) max.			80	80	80
Duración de vida(Ciclos)					
Mecánica	Sin mantenimiento		20,000	20,000	20,000
	Con mantenimiento		30,000	30,000	30,000
Eléctrica	Sin mantenimiento		5,000	5,000	5,000
	Con mantenimiento		10,000	10,000	10,000
Peso					
3 Polos	Tipo extraíble		63	87	63
	Tipo fijo	Kg	34	44	34
4 Polos	Tipo extraíble		74	103	74
	Tipo fijo		44	55	44
Dimensiones (WxHxD)					
Internos	Tipo extraíble		328x460x368.4	399x460x368.4	328x460x368.4
	Tipo fijo	mm	337.4x404.4x295.8	408.4x404.4x295.8	337.4x404.4x295.8
	Tipo extraíble		413x460x368.4	514x460x368.4	413x460x368.4
	Tipo fijo		422.4x404.4x295.8	523.4x404.4x295.8	422.4x404.4x295.8

Notas

- 1) 70 kA certificado en DEKRA
- 2) 4,000 AF
- 3) En caso de MCR y ajustes anulados, el INST es 50 ms.

CÓDIGO	REFERENCIA	DESCRIPCIÓN	PRECIO UNITARIO
--------	------------	-------------	-----------------

MONOPOLARES

	In (A)	Curva de disparo	IEC/EN60898-1		IEC/EN60947-2			
HYU0544	HGD63M1PMCS0000C00001	1					\$ 28.200	
HYU0545	HGD63M1PMCS0000C00002	2					\$ 28.200	
HYU0546	HGD63M1PMCS0000C00003	3					\$ 28.200	
HYU0547	HGD63M1PMCS0000C00004	4					\$ 18.200	
HYU0548	HGD63M1PMCS0000C00006	6					\$ 18.200	
HYU0549	HGD63M1PMCS0000C00010	10					\$ 18.200	
HYU0550	HGD63M1PMCS0000C00016	16	C	127V=10KA	220V=6KA	127V=15KA	220V=10KA	\$ 18.200
HYU0551	HGD63M1PMCS0000C00020	20					\$ 18.200	
HYU0552	HGD63M1PMCS0000C00025	25					\$ 18.200	
HYU0553	HGD63M1PMCS0000C00032	32					\$ 18.200	
HYU0554	HGD63M1PMCS0000C00040	40					\$ 18.200	
HYU0555	HGD63M1PMCS0000C00050	50					\$ 18.200	
HYU0556	HGD63M1PMCS0000C00063	63					\$ 18.200	



HGD63N 1 POLOS



HGD63N 2 POLOS



HGD63N 3 POLOS

BIPOLARES

	In (A)	Curva de disparo	IEC/EN60898-1		IEC/EN60947-2			
HYU0557	HGD63M2PMCS0000C00001	1					\$ 54.400	
HYU0558	HGD63M2PMCS0000C00002	2					\$ 54.400	
HYU0559	HGD63M2PMCS0000C00003	3					\$ 54.400	
HYU0560	HGD63M2PMCS0000C00004	4					\$ 54.400	
HYU0561	HGD63M2PMCS0000C00006	6					\$ 36.300	
HYU0562	HGD63M2PMCS0000C00010	10					\$ 36.300	
HYU0563	HGD63M2PMCS0000C00016	16	C	127V=10KA	220V=6KA	127V=15KA	220V=10KA	\$ 36.300
HYU0564	HGD63M2PMCS0000C00020	20					\$ 36.300	
HYU0565	HGD63M2PMCS0000C00025	25					\$ 36.300	
HYU0566	HGD63M2PMCS0000C00032	32					\$ 36.300	
HYU0567	HGD63M2PMCS0000C00040	40					\$ 36.300	
HYU0568	HGD63M2PMCS0000C00050	50					\$ 36.300	
HYU0569	HGD63M2PMCS0000C00063	63					\$ 36.300	

TRIPOLARES

	In (A)	Curva de disparo	IEC/EN60898-1		IEC/EN60947-2			
HYU0570	HGD63M3PMCS0000C00001	1					\$ 72.500	
HYU0571	HGD63M3PMCS0000C00002	2					\$ 72.500	
HYU0572	HGD63M3PMCS0000C00003	3					\$ 72.500	
HYU0573	HGD63M3PMCS0000C00004	4					\$ 54.500	
HYU0574	HGD63M3PMCS0000C00006	6					\$ 54.500	
HYU0575	HGD63M3PMCS0000C00010	10					\$ 54.500	
HYU0576	HGD63M3PMCS0000C00016	16	C	127V=10KA	220V=6KA	127V=15KA	220V=10KA	\$ 54.500
HYU0577	HGD63M3PMCS0000C00020	20					\$ 54.500	
HYU0578	HGD63M3PMCS0000C00025	25					\$ 54.500	
HYU0579	HGD63M3PMCS0000C00032	32					\$ 54.500	
HYU0580	HGD63M3PMCS0000C00040	40					\$ 54.500	
HYU0581	HGD63M3PMCS0000C00050	50					\$ 54.500	
HYU0582	HGD63M3PMCS0000C00063	63					\$ 54.500	

MINI INTERRUPTORES MCB



CÓDIGO	REFERENCIA	DESCRIPCIÓN				PRECIO UNITARIO
--------	------------	-------------	--	--	--	-----------------

MONOPOLARES

		In (A)	Curva de disparo	IEC/EN60898-1		IEC/EN60947-2		
HYU0505	HGD63P1PMCS0000C00001	1						\$ 28.200
HYU0506	HGD63P1PMCS0000C00002	2						\$ 28.200
HYU0507	HGD63P1PMCS0000C00003	3						\$ 28.200
HYU0508	HGD63P1PMCS0000C00004	4						\$ 28.200
HYU0509	HGD63P1PMCS0000C00006	6						\$ 25.100
HYU0510	HGD63P1PMCS0000C00010	10						\$ 25.100
HYU0511	HGD63P1PMCS0000C00016	16	C	127V=15KA	220V=10KA	127V=20KA	220V=15KA	\$ 25.100
HYU0512	HGD63P1PMCS0000C00020	20						\$ 25.100
HYU0513	HGD63P1PMCS0000C00025	25						\$ 25.100
HYU0514	HGD63P1PMCS0000C00032	32						\$ 25.100
HYU0515	HGD63P1PMCS0000C00040	40						\$ 25.100
HYU0516	HGD63P1PMCS0000C00050	50						\$ 25.100
HYU0517	HGD63P1PMCS0000C00063	63						\$ 25.100



HGD63N 1 POLOS

BIPOLARES

		In (A)	Curva de disparo	IEC/EN60898-1		IEC/EN60947-2		
HYU0518	HGD63P2PMCS0000C00001	1						\$ 77.800
HYU0519	HGD63P2PMCS0000C00002	2						\$ 77.800
HYU0520	HGD63P2PMCS0000C00003	3						\$ 77.800
HYU0521	HGD63P2PMCS0000C00004	4						\$ 77.800
HYU0522	HGD63P2PMCS0000C00006	6						\$ 52.300
HYU0523	HGD63P2PMCS0000C00010	10						\$ 52.300
HYU0524	HGD63P2PMCS0000C00016	16	C	127V=15KA	220V=10KA	127V=20KA	220V=15KA	\$ 52.300
HYU0525	HGD63P2PMCS0000C00020	20						\$ 52.300
HYU0526	HGD63P2PMCS0000C00025	25						\$ 52.300
HYU0527	HGD63P2PMCS0000C00032	32						\$ 52.300
HYU0528	HGD63P2PMCS0000C00040	40						\$ 77.800
HYU0529	HGD63P2PMCS0000C00050	50						\$ 77.800
HYU0530	HGD63P2PMCS0000C00063	63						\$ 77.800



HGD63N 2 POLOS

TRIPOLARES

		In (A)	Curva de disparo	IEC/EN60898-1		IEC/EN60947-2		
HYU0531	HGD63P3PMCS0000C00001	1						\$ 83.600
HYU0532	HGD63P3PMCS0000C00002	2						\$ 83.600
HYU0533	HGD63P3PMCS0000C00003	3						\$ 83.600
HYU0534	HGD63P3PMCS0000C00004	4						\$ 83.600
HYU0535	HGD63P3PMCS0000C00006	6						\$ 83.600
HYU0536	HGD63P3PMCS0000C00010	10						\$ 83.600
HYU0537	HGD63P3PMCS0000C00016	16	C	127V=15KA	220V=10KA	127V=20KA	220V=15KA	\$ 83.600
HYU0538	HGD63P3PMCS0000C00020	20						\$ 83.600
HYU0539	HGD63P3PMCS0000C00025	25						\$ 83.600
HYU0540	HGD63P3PMCS0000C00032	32						\$ 83.600
HYU0541	HGD63P3PMCS0000C00040	40						\$ 89.600
HYU0542	HGD63P3PMCS0000C00050	50						\$ 89.600
HYU0543	HGD63P3PMCS0000C00063	63						\$ 89.600



HGD63N 3 POLOS



HRC63S

CÓDIGO	REFERENCIA	DESCRIPCIÓN	PRECIO UNITARIO			
INTERRUPTORES DIFERENCIALES HRC Standard Type						
		Corriente Nominal In (A)	Corriente residual de operación (mA)			
		Número de Polos	Tipo			
HYU0587	HRC63S2PG4S0000C00025G	25	30	2P (1P+N)	AC	\$ 127.800
HYU0588	HRC63S2PG4S0000C00040G	40	30	2P (1P+N)	AC	\$ 127.800
HYU0589	HRC63S4PG4S0000C00025G	25	30	4P (3P+N)	AC	\$ 187.500
HYU0590	HRC63S4PG4S0000C00040G	40	30	4P (3P+N)	AC	\$ 187.500
HYU0591	HRC63S4PG4S0000C00063G	63	30	4P (3P+N)	AC	\$ 227.400
HYU0592	HRC1004PG4S0000C00080G	80	30	4P (3P+N)	AC	\$ 372.700
HYU0593	HRC63S2PG4S0000C00025F	25	30	2P (1P+N)	A	\$ 232.100
HYU0594	HRC63S2PG4S0000C00040F	40	30	2P (1P+N)	A	\$ 232.100
HYU0595	HRC63S4PG4S0000C00025F	25	30	4P (3P+N)	A	\$ 283.900
HYU0596	HRC63S4PG4S0000C00040F	40	30	4P (3P+N)	A	\$ 283.900
HYU0597	HRC63S4PG4S0000C00063F	63	30	4P (3P+N)	A	\$ 283.900
HYU0598	HRC100S4PG4S0000C00080F	80	30	4P (3P+N)	A	\$ 484.000
ACCESORIOS						
HYU0583	AUX HGD63P	Contacto estado AUX HGD63P COM-NA-1NC HGD63-M/P		\$89.300		
HYU0584	ALT HGD63P	Contacto falla ALT HGD63P COM-NA-1NC HGD63-M/P		\$89.300		
HYU0585	SHT HGD63PS2	Bobina de disparo 220VAC SHT HGD63PS2 , Para HGD63M/P		\$71.900		
HYU0586	UVTHGD63PU2	Bobina de mínima tensión 230VAC UVTHGD63PU2, Para HGD63M/P		\$104.600		
HYU0599	PLD M63 A	Sistema para candado PLD M63 a uso con HGD, candado 8mm		\$28.200		



CERTIFICADO
CONFORMIDAD
RETIE
EL-CS-200053

Intertek

* Producto bajo pedido

** Producto última vez en lista de precios o hasta agotar inventarios

NU Producto Nuevo

MINI INTERRUPTORES MCB

CÓDIGO	REFERENCIA	DESCRIPCIÓN	PRECIO UNITARIO
--------	------------	-------------	-----------------

MONOPOLARES

		In (A)	Curva de disparo	Capacidad de interrupción 240/440V (kA) IEC 60898	
** HYU0040	HGD63 N1PMCS0000C 00004	4		6	\$ 10.900
** HYU0048	HGD63 N1PMCS0000C 00050	50	C	6	\$ 9.400
** HYU0049	HGD63 N1PMCS0000C 00063	63	C	6	\$ 9.400



HGD63N 1 POLOS

BIPOLARES

		In (A)	Curva de disparo	Capacidad de interrupción 240/440V (kA) IEC 60898	
** HYU0051	HGD63 N2PMCS0000C 00006	6	C	6	\$ 19.700
** HYU0052	HGD63 N2PMCS0000C 00010	10	C	6	\$ 21.800
** HYU0054	HGD63 N2PMCS0000C 00020	20	C	6	\$ 20.600



HGD63N 2 POLOS

TRIPOLARES

		In (A)	Curva de disparo	Capacidad de interrupción 240/440V (kA) IEC 60898	
** HYU0061	HGD63 N3PMCS0000C 00006	6	C	6	\$ 31.000
** HYU0062	HGD63 N3PMCS0000C 00010	10	C	6	\$ 31.900
** HYU0063	HGD63 N3PMCS0000C 00016	16	C	6	\$ 32.100
** HYU0064	HGD63 N3PMCS0000C 00020	20	C	6	\$ 33.100
** HYU0065	HGD63 N3PMCS0000C 00025	25	C	6	\$ 31.200
** HYU0066	HGD63 N3PMCS0000C 00032	32	C	6	\$ 32.700
** HYU0067	HGD63 N3PMCS0000C 00040	40	C	6	\$ 31.400
** HYU0068	HGD63 N3PMCS0000C 00050	50	C	6	\$ 30.200
** HYU0069	HGD63 N3PMCS0000C 00063	63	C	6	\$ 30.900



HGD63N 3 POLOS

* Producto bajo pedido

** Producto última vez en lista de precios o hasta agotar inventarios
NU Producto Nuevo



CÓDIGO	REFERENCIA	DESCRIPCIÓN	PRECIO UNITARIO
--------	------------	-------------	-----------------

MONOPOLARES

					Capacidad de interrupción 240/120V (kA) IEC 60947-2	
			In (A)	Curva de disparo		
**	HYU0001	HGD63 H1PMCS0000C 00001	1	C	10/20	\$ 12.900
**	HYU0003	HGD63 H1PMCS0000C 00003	3	C	10/20	\$ 14.700
**	HYU0004	HGD63 H1PMCS0000C 00004	4	C	10/20	\$ 12.100
**	HYU0009	HGD63 H1PMCS0000C 00025	25	C	10/20	\$ 14.000
**	HYU0010	HGD63 H1PMCS0000C 00032	32	C	10/20	\$ 14.600
**	HYU0011	HGD63 H1PMCS0000C 00040	40	C	10/20	\$ 12.100
**	HYU0012	HGD63 H1PMCS0000C 00050	50	C	10/20	\$ 12.100
**	HYU0013	HGD63 H1PMCS0000C 00063	63	C	10/20	\$ 12.100



HGD63H 1 POLO

BIPOLARES

					Capacidad de interrupción 240/120V (kA) IEC 60947-2	
			In (A)	Curva de disparo		
**	HYU0014	HGD63 H2PMCS0000C 00001	1	C	10/20	\$ 26.400
**	HYU0016	HGD63 H2PMCS0000C 00003	3	C	10/20	\$ 29.100
**	HYU0017	HGD63 H2PMCS0000C 00004	4	C	10/20	\$ 28.800
**	HYU0018	HGD63 H2PMCS0000C 00006	6	C	10/20	\$ 29.000
**	HYU0020	HGD63 H2PMCS0000C 00016	16	C	10/20	\$ 29.000
**	HYU0022	HGD63 H2PMCS0000C 00025	25	C	10/20	\$ 26.300
**	HYU0025	HGD63 H2PMCS0000C 00050	50	C	10/20	\$ 25.600



HGD63H 2 POLOS

MINI INTERRUPTORES MCB



CÓDIGO	REFERENCIA	DESCRIPCIÓN			PRECIO UNITARIO	
TRIPOLARES						
		In (A)	Curva de disparo	Capacidad de interrupción 240/120V (kA) IEC 60947-2		
** HYU0028	HGD63 H3PMCS0000C 00002	2	C	10/20	\$ 43.700	
** HYU0029	HGD63 H3PMCS0000C 00003	3	C	10/20	\$ 40.200	
** HYU0030	HGD63 H3PMCS0000C 00004	4	C	10/20	\$ 40.200	
** HYU0032	HGD63 H3PMCS0000C 00010	10	C	10/20	\$ 45.700	
** HYU0033	HGD63 H3PMCS0000C 00016	16	C	10/20	\$ 43.600	
** HYU0034	HGD63 H3PMCS0000C 00020	20	C	10/20	\$ 45.700	
** HYU0039	HGD63 H3PMCS0000C 00063	63	C	10/20	\$ 44.600	
INTERRUPTORES DIFERENCIALES HRC Deluxe Type						
		Corriente Nominal In (A)	Corriente residual de operación (mA)	Número de Polos	Tipo	
** HYU0085	HRC63 2PG4S0000C 00025G	25	30	2P (1P+N)	AC	\$ 71.000
** HYU0086	HRC63 2PG4S0000C 00040G	40	30	2P (1P+N)	AC	\$ 65.800
** HYU0087	HRC63 4PG4S0000C 00025G	25	30	4P (3P+N)	AC	\$ 91.400
** HYU0088	HRC63 4PG4S0000C 00040G	40	30	4P (3P+N)	AC	\$ 102.500
ACCESORIOS						
** HYU0070	AXT HGD63H	Contacto auxiliar y alarma 1NA+1NC para HGD63N/H				\$ 24.900



HGD63H 3 POLOS



HRC63 & HRC100

* Producto bajo pedido

** Producto última vez en lista de precios o hasta agotar inventarios

NU Producto Nuevo

Modelo	HGD-63N, 63 A	HGD-63H, 63 A	HGD-63M, 63 A	HGD-63P, 63 A
Norma de referencia	IEC/EN 60898-1	IEC/EN 60898-1 ; IEC/EN 60947-2	IEC/EN 60898-1, IEC/EN 60947-2	IEC/EN 60898-1, IEC/EN 60947-2
Núm. de polos	1P, 2P, 3P	1P, 2P, 3P	1P, 2P, 3P	1P, 2P, 3P
Intensidad nominal (In)	1, 2, 3, 4, 5, 6, 10, 16, 20, 25, 32, 40, 50, 63 A	1, 2, 3, 4, 5, 6, 10, 16, 20, 25, 32, 40, 50, 63 A	1, 2, 3, 4, 5, 6, 10, 16, 20, 25, 32, 40, 50, 63 A	1, 2, 3, 4, 5, 6, 10, 16, 20, 25, 32, 40, 50, 63 A
Tensión de empleo máx. (Ue)	AC 240/415 V	AC 240/415 V	AC 240/415 V	AC 240/415 V
Frecuencia (F)	50/60 Hz	50/60 Hz	50/60 Hz	50/60 Hz
Poder de corte (Icn)	6 kA (Ics=100 % Icn)	10 kA (Ics=100 % Icn)	6 kA (Ics=100 % Icn)	10 kA (Ics=75 % Icn)
Característica de disparo (curva)	(5-10) In - Curva C	(5-10) In - Curva C	(5-10) In - Curva C	(5-10) In - Curva C
Tensión asignada de aislamiento (Ui)	500 V	500 V	500 V	500 V
Tensión nominal de resistencia a los impulsos (Uimp)	4 kV	4 kV	4 kV	4 kV
Resistencia dieléctrica	2.5 kV	2.5 kV	2.5 kV	2.5 kV
Endurancia Eléctrica	10.000	10.000	10.000	10.000
Mecánica (núm. de maniobras)	20.000	20.000	20.000	20.000
Temperatura de funcionamiento	-5 °C a + 55 °C	-5 °C a + 55 °C	-5 °C a + 55 °C	-5 °C a + 55 °C
Humedad	95 % RH	95 % RH	95 % RH	95 % RH
Clase de limitación de energía	3	3	3	3
Tamaño del terminal (máx)	35 mm ²	35 mm ²	35 mm ²	35 mm ²
Par de apriete máximo	2 N·m	2 N·m	2 N·m	2 N·m
Vibración	3 g	3 g	3 g	3 g
Grado de protección IP	IP20	IP20	IP20	IP20
Indicador visual de posición de contacto	Rojo-ON, Verde-OFF	Rojo-ON, Verde-OFF	Rojo-ON, Verde-OFF	Rojo-ON, Verde-OFF
Peso neto por polo	0.125 kg	0.125 kg	0.125 kg	0.125 kg
Dimensiones (Alto x Profundo x Ancho) por polo	87.5 x 71.7 x 17.7 mm	87.5 x 71.7 x 17.7 mm	87.5 x 71.7 x 17.7 mm	87.5 x 71.7 x 17.7 mm
Montaje	Riel DIN	Riel DIN	Riel DIN	Riel DIN
Posición de instalación	Vertical/Horizontal	Vertical/Horizontal	Vertical/Horizontal	Vertical/Horizontal
Carcasa y cubierta	Material termoplástico moldeado, ignífugo	Material termoplástico moldeado, ignífugo	Material termoplástico moldeado, ignífugo	Material termoplástico moldeado, ignífugo
Tipo conexión peine lado superior/inferior	Tipo Pin/Horquilla (Inferior)	Tipo Pin/Horquilla (Inferior)	Tipo Pin/Horquilla (Inferior)	Tipo Pin/Horquilla (Inferior)
AUX/ALT/SHT/UVT/OVT	Sí	Sí	Sí	Sí

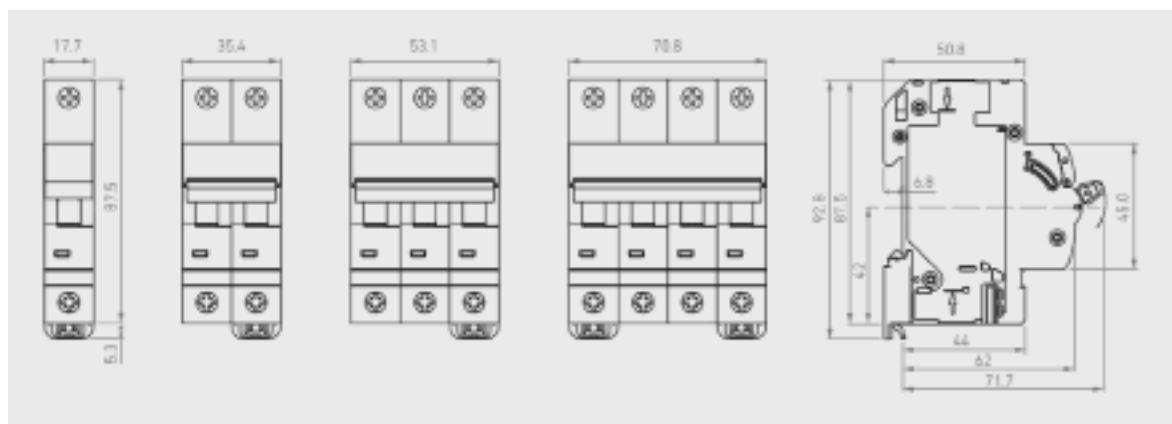

ESPECIFICACIONES TÉCNICAS

INTERRUPTORES DIFERENCIALES - RCB







Modelo	HRC63	HRC100, 100 AF
Norma de referencia	IEC/EN 61008-1	IEC/EN 61008-1
Núm. de polos	2P (N + 1P), 4P (N + 3P)	2P (N + 1P), 4P (N + 3P)
Intensidad nominal (In)	25, 40, 63 A	80 A
Tensión de empleo (Ue)	AC 240/415 V	AC 240/415 V
Frecuencia (F)	50/60 Hz	50/60 Hz
Poder de corte (Inc)	10 kA	10 kA
Sensibilidad (IΔc)	30 mA	30 mA
Poder asignado de cierre (Lm)	630 A o 10 In, el que sea mayor	630 A o 10 In, el que sea mayor
Carac. en función de la presencia fugas con componente en cc	Tipo 'A' y tipo 'AC'	Tipo 'A' y tipo 'AC'
Tiempo de disparo	1 IΔn < 300 ms, 5 IΔn < 40 ms	1 IΔn < 300 ms, 5 IΔn < 40 ms
Tensión de aislamiento (Ui)	500 V	500 V
Tensión nominal de resistencia impulsos (Uimp)	4 kV	4 kV
Resistencia dieléctrica	2.5 kV	2.5 kV
Endurancia Eléctrica / Mecánica de maniobras) Mínimo	10,000/20,000	10,000/20,000
Temperatura de funcionamiento	-25 °C a + 55 °C	-25 °C a + 55 °C
Humedad	95 % RH	95 % RH
Tamaño del terminal (máx.)	35 mm ²	50 mm ²
Par de apriete máximo	2 N·m	2.5 N·m
Vibración	3 g	3 g
Grado de protección IP	IP20	IP20
Indicador visual de posición contacto	Rojo-ON, Verde-OFF	Rojo-ON, Verde-OFF
Peso neto en kg	0.215 kg (en 2P) ; 0.335 kg (en 4P)	0.230 kg (en 2P) ; 0.404 kg (en 4P)
Dimensiones (Alto x Profundo Ancho) por polo en mm	87.5 x 71.7 x 35.9 mm (en 2P) ; 87.5 x 71.7 x 72.0 mm (en 4P)	88.2 x 71.7 x 35.9 mm (en 2P) ; 88.2 x 71.7 x 72.0 mm (en 4P)
Montaje	Clip 35 mm x 7.5 mm carril DIN	Clip 35 mm x 7.5 mm carril DIN
Posición de instalación	Vertical/Horizontal	Vertical/Horizontal
Carcasa y cubierta	Material termoplástico moldeado, ignífugo	Material termoplástico moldeado, ignífugo
Tipo conexión peine	Tipo Pin/Horquilla	Tipo Pin/Horquilla
Contactos auxiliares	Sí	No

Efectos de la corriente en el cuerpo Humano

1-10 mA	10 mA	20-30 mA	70-100 mA	500 mA
1 ~ 9 mA	Sensación de cosquilleo			
10 mA	Contracción de Músculos, la persona tiende a mantener el conductor			
20 ~ 30 mA	Contracción de músculos más fuerte, puede causar parálisis respiratoria			
70 ~ 100 mA	Fibrilación cardiaca, situación muy peligrosa, daños irreversibles			
500 mA	Ataque cardiaco fulminante, muerte			

ESPECIFICACIONES TÉCNICAS

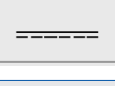
INTERRUPTORES DIFERENCIALES - RCB

Tipos de diferenciales	AC	A	F (SI) Super inmunizado	B
CARACTERÍSTICAS	Detecta solo corriente residual alterna. Tiene nula efectividad ante armónicos y otros. Los semiconductores generan corrientes de fuga que no son detectadas por los de clase AC	Detecta corriente residual y pulsante que ocurre repentinamente o aumenta lentamente en magnitud.	Detecta corriente residual alterna hasta 1kHz y pulsante, así como frecuencias mezcladas por fugas en la red eléctrica	Detecta corriente residual alterna hasta 1kHz y pulsante y pura continua. Se utilizan para detectar corrientes de fuga de DC.
TIPO DE CARGA	Cargas resistivas, inductivas y capacitivas sin componentes electrónicos. Ejemplos: Iluminación halógena, hornos, calentadores, Estufas eléctricas.	Cargas con componentes electrónicos. Ejemplos: Aire acondicionado, Iluminación led, computadores	Equipos con control de frecuencia o rectificación de AC Ejemplos: Variadores de frecuencia, Aire acondicionado con variador de frecuencia, UPS	Equipos especiales. Ejemplos: Cargadores de vehículos eléctricos, Inversores y cargadores de baterías trifásicos
FORMA DE ONDA				
	SI	SI	SI	SI
		SI	SI	SI
		SI	SI	SI
		SI	SI	SI
			SI	SI
				SI
				SI

CÓDIGO	REFERENCIA	DESCRIPCIÓN	PRECIO UNITARIO
--------	------------	-------------	-----------------

GUARDAMOTORES					
		Rango de Corriente (A)	Capacidad de ruptura (Icu)		
			220V	440V	
HYU0274	MMS32 K1P00	0.63 - 1	100	100	\$ 162.100
HYU0275	MMS32 K01P6	1 - 1.6	100	100	\$ 162.100
HYU0276	MMS32 K02P5	1.6 - 2.5	100	100	\$ 162.100
HYU0277	MMS32 K0004	2.5 - 4	100	100	\$ 162.100
HYU0278	MMS32 K06P3	4 - 6.3	100	50	\$ 162.100
HYU0279	MMS32 K0010	6 - 10	100	15	\$ 162.100
HYU0280	MMS32 K0014	9 - 14	100	8	\$ 162.100
HYU0281	MMS32 K0018	13 - 18	100	8	\$ 162.100
HYU0282	MMS32 K0023	17 - 23	50	6	\$ 162.100
HYU0283	MMS32 K0025	20 - 25	50	6	\$ 162.100
HYU0284	MMS32 K0032	24 - 32	50	6	\$ 162.100
HYU0285	MMS80 K0040	25 - 40	100	50	\$ 477.000
HYU0286	MMS80 K0063	40 - 63	100	50	\$ 517.500
HYU0287	MMS80 K0080	56 - 80	100	10	\$ 526.400



MMS32 -MMS80



MMS32 -KA

ACCESORIOS			
Para Guardamotor MMS32K			
HYU0288	MMS32 KAUXT11	Contacto Auxiliar de estado de 1NA + 1 NC, montaje Frontal para MMS32K	\$ 32.900
HYU0289	MMS32 KAUXS11	Contacto Auxiliar de estado de 1NA + 1 NC, montaje Lateral para MMS32K	\$ 42.300
HYU0290	MMS80 KAUXS11	Contacto Auxiliar de estado de 1NA + 1 NC, montaje Lateral para MMS80K	\$ 67.300
HYU0292	MS32 KAXT1010	Contacto Auxiliar de falla (1 NA) y estado (1NA), montaje lateral, para MMS32K	\$ 77.600



CÓDIGO	REFERENCIA	DESCRIPCIÓN				PRECIO UNITARIO
--------	------------	-------------	--	--	--	-----------------

CONTACTORES AC HGC9-100

		Corriente Max de Operación 220/440V (A)		Potencia Max. De Operación en AC3 (kW)		Tensión de operación de la bobina (V)	Contactos Auxiliares	
		AC1	AC3	220V	440V			
HYU0098	HGC9 11NS A110	25	9	2,5	4	AC110	1NA+1NC	\$ 115.200
HYU0099	HGC9 11NS A220	25	9	2,5	4	AC220	1NA+1NC	\$ 115.200
HYU0102	HGC12 11NS A110	30	12	3,5	5,5	AC110	1NA+1NC	\$ 126.900
HYU0103	HGC12 11NS A220	30	12	3,5	5,5	AC220	1NA+1NC	\$ 126.900
HYU0106	HGC18 11NS A110	40	18	4,5	7,5	AC110	1NA+1NC	\$ 145.500
HYU0107	HGC18 11NS A220	40	18	4,5	7,5	AC220	1NA+1NC	\$ 145.500
HYU0110	HGC25 11NS A110	45	25	5,5	11	AC110	1NA+1NC	\$ 182.000
HYU0111	HGC25 11NS A220	45	25	5,5	11	AC220	1NA+1NC	\$ 182.000
HYU0114	HGC32 11NS A110	55	32	7,5	15	AC110	1NA+1NC	\$ 192.700
HYU0115	HGC32 11NS A220	55	32	7,5	15	AC220	1NA+1NC	\$ 192.700
HYU0118	HGC40 11NS A110	60	40	11	18,5	AC110	1NA+1NC	\$ 245.600
HYU0119	HGC40 11NS A220	60	40	11	18,5	AC220	1NA+1NC	\$ 245.600
HYU0122	HGC50 22NS A110	70	50	15	22	AC110	2NA+2NC	\$ 375.800
HYU0123	HGC50 22NS A220	70	50	15	22	AC220	2NA+2NC	\$ 375.800
HYU0126	HGC65 22NS A110	85	65	18,5	30	AC110	2NA+2NC	\$ 440.300
HYU0127	HGC65 22NS A220	85	65	18,5	30	AC220	2NA+2NC	\$ 440.300
HYU0130	HGC85 22NS A110	125	85	25	45	AC110	2NA+2NC	\$ 550.100
HYU0131	HGC85 22NS A220	125	85	25	45	AC220	2NA+2NC	\$ 550.100
HYU0134	HGC100 22NS A110	145	100	30	55	AC110	2NA+2NC	\$ 666.800
HYU0135	HGC100 22NS A220	145	100	30	55	AC220	2NA+2NC	\$ 666.800



HGC9 - 18



HGC85 - 100



HGC130- 300



HGC400- 800

CONTACTORES AC HGC130-300

		Corriente Max de Operación 220/440V (A)		Potencia Max. De Operación en AC3 (kW)		Tensión de operación de la bobina (V)	Contactos Auxiliares	
		AC1	AC3	220V	440V			
HYU0138	HGC130 22NS F220	180	130	40	65	AC/DC 100 ~ 240	2NA+2NC	\$ 1.127.300
HYU0141	HGC150 22NS F220	210	150	45	75	AC/DC 100 ~ 240	2NA+2NC	\$ 1.257.900
HYU0143	HGC185 22NS F220	275	185	55	90	AC/DC 100 ~ 240	2NA+2NC	\$ 1.714.900
HYU0145	HGC225 22NS F220	315	225	75	132	AC/DC 100 ~ 240	2NA+2NC	\$ 1.850.000
HYU0147	HGC265 22NS F220	350	265	80	147	AC/DC 100 ~ 240	2NA+2NC	\$ 2.212.500
HYU0149	HGC300 22NS F220	400	300	90	160	AC/DC 100 ~ 240	2NA+2NC	\$ 2.932.600

CONTACTORES AC HGC400-800

		Corriente Max de Operación 220/440V (A)		Potencia Max. De Operación en AC3 (kW)		Tensión de operación de la bobina (V)	Contactos Auxiliares	
		AC1	AC3	220V	440V			
HYU0151	HGC400 22NS F220	500	400	125	220	AC/DC 100 ~ 240	2NA+2NC	\$ 3.779.100
HYU0153	HGC500 22NS F220	550	500	140	250	AC/DC 100 ~ 240	2NA+2NC	\$ 5.000.900
HYU0155	HGC630 22NS F220	750	630	190	330	AC/DC 220	2NA+2NC	\$ 10.459.900
HYU0157	HGC800 22NS F220	900	800	220	440	AC/DC 220	2NA+2NC	\$ 11.943.200





CÓDIGO	REFERENCIA	DESCRIPCIÓN	PRECIO UNITARIO
--------	------------	-------------	-----------------

CONTACTORES DC HGC9-65

		Corriente Max de Operación 220/440V (A)		Potencia Max. De Operación en AC3 (kW)		Tensión de operación de la bobina (V)		
		AC1	AC3	220V	440V			
*	HYU0159	HGC9 11NS D024	25	9	2,5	4	DC24	\$ 178.300
*	HYU0162	HGC12 11NS D024	30	12	3,5	5,5	DC24	\$ 201.400
*	HYU0165	HGC18 11NS D024	40	18	4,5	7,5	DC24	\$ 209.900
*	HYU0168	HGC25 11NS D024	45	25	5,5	11	DC24	\$ 263.800
*	HYU0171	HGC32 11NS D024	55	32	7,5	15	DC24	\$ 282.000
*	HYU0174	HGC40 11NS D024	60	40	11	18,5	DC24	\$ 320.200
*	HYU0177	HGC50 21NS D024	70	50	15	22	DC24	\$ 463.900
*	HYU0180	HGC65 21NS D024	85	65	18,5	30	DC24	\$ 540.100



HGC 9 - 65



HGC 12C-50C

CONTACTORES PARA CONDENSADORES, CON RESISTENCIAS DE PRECARGA

		Potencia Reactiva kVAR		Tensión de operación de la bobina (V)	Contactos Auxiliares		
		220V AC	440V AC				
	HYU0198	HGC12C 22NS A110	6,7	12,0	110V AC	2NA+2NC	\$ 300.600
	HYU0199	HGC12C 22NS A220	6,7	12,0	220 VAC	2NA+2NC	\$ 300.600
	HYU0201	HGC18C 22NS A110	8,5	16,7	110V AC	2NA+2NC	\$ 317.300
	HYU0202	HGC18C 22NS A220	8,5	16,7	220 VAC	2NA+2NC	\$ 317.300
	HYU0204	HGC25C 22NS A110	10,0	20,0	110V AC	2NA+2NC	\$ 359.100
	HYU0205	HGC25C 22NS A220	10,0	20,0	220 VAC	2NA+2NC	\$ 359.100
	HYU0207	HGC40C 22NS A110	15,0	29,0	110V AC	2NA+2NC	\$ 500.300
	HYU0208	HGC40C 22NS A220	15,0	29,0	220 VAC	2NA+2NC	\$ 500.300
	HYU0210	HGC50C 22NS A110	19,0	40,0	110V AC	2NA+2NC	\$ 564.100
	HYU0211	HGC50C 22NS A220	19,0	40,0	220 VAC	2NA+2NC	\$ 564.100

* Producto bajo pedido

** Producto última vez en lista de precios o hasta agotar inventarios

NU Producto Nuevo



CÓDIGO	REFERENCIA	DESCRIPCIÓN	PRECIO UNITARIO
--------	------------	-------------	-----------------

CONTACTORES AUXILIARES

		Tensión de operación de la bobina (V)	Contactos Auxiliares	
HYU0183	HGR 22NS A024	24V AC	2NA+2NC	\$ 136.200
HYU0184	HGR 22NS A110	110 VAC	2NA+2NC	\$ 116.100
HYU0185	HGR 22NS A220	220V AC	2NA+2NC	\$ 116.100
HYU0187	HGR 31NS A024	24V AC	3NA+1NC	\$ 136.200
HYU0188	HGR 31NS A110	110V AC	3NA+1NC	\$ 116.100
HYU0189	HGR 31NS A220	220 VAC	3NA+1NC	\$ 116.100
HYU0192	HGR 40NS A110	110V AC	4NA	\$ 116.100
HYU0193	HGR 40NS A220	220V AC	4NA	\$ 116.100
HYU0195	HGR 22PS D024	24V DC	2NA+2NC	\$ 236.800
HYU0196	HGR 31PS D024	24V DC	3NA+1NC	\$ 236.800
HYU0197	HGR 40PS D024	24V DC	4NA	\$ 236.800



HGR

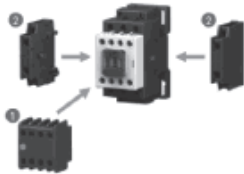

1) Contacto auxiliar (frontal)
2) Contacto auxiliar (lateral)

HG

BLOQUES DE CONTACTOS AUXILIARES

		Tipo de montaje	Para contactor	Contactos Auxiliares	
HYU0213	HG CTB 11NS	Frontal	HGC9 ~ 100 & HGR	1NA+1NC	\$ 40.700
HYU0215	HG CTB 22NS	Frontal	HGC9 ~ 100 & HGR	2NA+2NC	\$ 66.200
HYU0218	HGC SB40 11NS	Lateral	HGC9 ~ 40	1NA+1NC	\$ 30.000
HYU0219	HGC SB800 11NS	Lateral	HGC115 ~ 800	1NA+1NC	\$ 78.300

ENCLAVAMIENTO MECÁNICO PARA CONTACTORES

		Para contactor	
HYU0220	HGC IU40	HGC9 ~ 40	\$ 56.800
HYU0221	HGC IU100	HGC50 ~ 100	\$ 60.100
HYU0222	HGC IU265	HGC115 ~ 265	\$ 63.500
HYU0223	HGC IU800	HGC300 ~ 800	\$ 450.000



HGC IU



* Producto bajo pedido
** Producto última vez en lista de precios o hasta agotar inventarios
NU Producto Nuevo

CÓDIGO	REFERENCIA	DESCRIPCIÓN	PRECIO UNITARIO
--------	------------	-------------	-----------------

BOBINAS PARA CONTACTORES HGC

		Tensión de operación de la bobina (V)	Aplica a:		
*	HYU0485	HGC OL18 A024	24V AC	HGC9 ~ 18	BAJO CONSULTA
NU	HYU0486	HGC OL18 A110	110V AC	HGC9 ~ 18	BAJO CONSULTA
NU	HYU0487	HGC OL18 A220	220V AC	HGC9 ~ 18	BAJO CONSULTA
*	HYU0488	HGC OL18 A440	440V AC	HGC9 ~ 18	BAJO CONSULTA
*	HYU0224	HGC OL40 A024	24V AC	HGC25 ~ 40	\$ 56.200
	HYU0225	HGC OL40 A110	110V AC	HGC25 ~ 40	\$ 56.200
	HYU0226	HGC OL40 A220	220V AC	HGC25 ~ 40	\$ 56.200
*	HYU0227	HGC OL40 A440	440V AC	HGC25 ~ 40	\$ 56.200
*	HYU0228	HGC OL65 A024	24V AC	HGC50 ~ 65	\$ 66.000
	HYU0229	HGC OL65 A110	110V AC	HGC50 ~ 65	\$ 66.000
	HYU0230	HGC OL65 A220	220V AC	HGC50 ~ 65	\$ 66.000
*	HYU0231	HGC OL65 A440	440V AC	HGC50 ~ 65	\$ 66.000
*	HYU0232	HGC OL100 A024	24V AC	HGC75 ~ 100	\$ 80.700
	HYU0233	HGC OL100 A110	110V AC	HGC75 ~ 100	\$ 80.700
	HYU0234	HGC OL100 A220	220V AC	HGC75 ~ 100	\$ 80.700
*	HYU0235	HGC OL100 A440	440V AC	HGC75 ~ 100	\$ 80.700
	HYU0236	HGC OL150 F220	220V AC	HGC115 ~ 150	\$ 375.400
*	HYU0237	HGC OL150 F440	440V AC	HGC115 ~ 150	\$ 375.400
	HYU0238	HGC OL265 F220	220V AC	HGC185 ~ 265	\$ 581.000
*	HYU0239	HGC OL265 F440	440V AC	HGC185 ~ 265	\$ 581.000
**	HYU0240	HGC OL500 F220	220V AC	HGC300 ~ 500	\$ 839.500
*	HYU0241	HGC OL500 F440	440V AC	HGC300 ~ 500	\$ 839.500
	HYU0615	HGC COL800 F220	220V AC/DC	HGC630 ~ 800	\$ 1.607.900
*	HYU0242	HGC OL40 D024	24V DC	HGC25 ~ 40	\$ 63.200
*	HYU0243	HGC OL40 D048	48V DC	HGC25 ~ 40	\$ 63.200
*	HYU0244	HGC OL40 D110	110V DC	HGC25 ~ 40	\$ 63.200
*	HYU0245	HGC OL65 D024	24V DC	HGC50 ~ 65	\$ 70.700
*	HYU0246	HGC OL65 D048	48V DC	HGC50 ~ 65	\$ 70.700
*	HYU0247	HGC OL65 D110	110V DC	HGC50 ~ 65	\$ 70.700

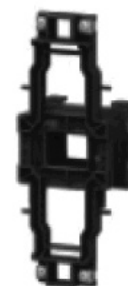

HGC OL18-100



HGC115- 800
Cambio de Bobina sin uso de herramienta

* Producto bajo pedido

** Producto última vez en lista de precios o hasta agotar inventarios

NU Producto Nuevo

MEDIDAS			
Tamaño AC	Ancho (mm)	Alto (mm)	Profundo (mm)
HGC9 ~ 18	45	94,2	91,2
HGC25 ~ 40	45	99,6	96,6
HGC50 ~ 65	55	123,6	129
HGC85 ~ 100	70	146	153
HGC130 ~ 150	103	155	145,1
HGC185 ~ 265	138	204	174,2
HGC300 ~ 500	163	243	203
HGC630 ~ 800	276	314	255,3

Certificaciones de Contactores:

- CB Certification (KTC) : IEC 60947-4-1
- CE Mark
- CCC Certification
- Vessel Certification : LR, ABS, KR, BV, DNV-GL, NK, RINA



ESPECIFICACIONES TÉCNICAS

CONTACTORES MC

Modelo				HGC9	HGC12	HGC18
Norma IEC 60947-4						
Tensión de aislamiento [Ui] V				800	800	800
Tensión nominal de empleo [Ue] V				690	690	690
Tensión nominal impulsional [Uimp] kV				6	6	6
Corriente nominal Ith (AC1) A				25	30	40
AC3	200 ~ 240 V	kW/A		2.5/9	3.5/12	4.5/18
	380 ~ 440 V			4/9	5.5/12	7.5/18
	500 ~ 550 V			4/7	7.5/12	8.5/13
	660 ~ 690 V			4/6	7.5/9	7.5/9
	1,000 V			-	-	-
	Vida útil	Eléctrica	x10,000	250	250	250
	Mecánica	x10,000	1500	1500	1,500	
AC4	200 ~ 240 V	kW/A		1.5/8	2.2/11	3.7/16
	380 ~ 440 V			2.2/6	4/9	4/11
	Vida útil eléctrica		x10,000	3	3	3
Método de instalación				Tornillo y Carril DIN		
Contactos auxiliares						
Estándar	AC			1NA 1NC o 2NA 2NC		
	AC (Tipo B)			1NA		
	DC			1NA 1NC o 2NA 2NC		
Adicional	AC			2NA 2NC		
	DC			2NA 2NC		
Dimensiones						
AC	W×H×D	mm		45×94.2×91.1		
AC (Tipo B)				45×75×86		
DC				45×94.2×124		
Operación bobina AC	Cierre		VA	80	80	80
	Mantenimiento		VA/W	10/2.5	10/2.5	10/2.5
Operación bobina DC	Cierre		W	10	10	10
	Mantenimiento		W	10	10	10

ESPECIFICACIONES TÉCNICAS

CONTACTORES MC

Modelo				HGC25	HGC32	HGC40	HGC50	HGC65	HGC85	HGC100
Norma IEC 60947-4										
Tensión de aislamiento [Ui] V				800	800	800	1,000	1,000	1,000	1,000
Tensión nominal de empleo [Ue] V				690	690	690	690	690	690	690
Tensión nominal impulsional [Uimp] kV				6	6	6	8	8	8	8
Corriente nominal Ith (AC1) A				45	55	60	70	85	125	145
AC3	200 ~ 240 V	kW/A		5.5/25	7.5/32	11/40	15/50	18.5/65	25/85	30/100
	380 ~ 440 V			11/25	15/32	18.5/40	22/50	30/65	45/85	55/100
	500 ~ 550 V			15/22	18.5/28	22/32	30/43	33/60	50/75	55/85
	660 ~ 690 V			15/17	18.5/20	22/23	30/28	33/35	45/45	50/65
	1,000 V			-	-	-	-	-	-	-
	Vida útil	Eléctrica	x10,000	250	200	200	200	200	200	200
	Mecánica	x10,000	1,500	1,500	1,500	1,500	1,500	1,000	1,000	
AC4	200 ~ 240 V	kW/A		3.7/18	4.5/22	5.5/25	7.5/35	11/50	15/65	17/72
	380 ~ 440 V			5.5/13	7.5/17	11/24	15/32	22/47	30/62	33/68
	Vida útil eléctrica		x10,000	3	3	3	3	3	3	3
Método de instalación				Tornillo y Carril DIN			Tornillo y Carril DIN		Tornillo y Carril DIN	
Contactos auxiliares										
Estándar	AC			1NA 1NC o 2NA 2NC			2NA 2NC		2NA 2NC	
	AC (Tipo B)			1NA			1NA		1NA	
	DC			1NA 1NC o 2NA 2NC			2NA 1NC		2NA 1NC	
Adicional	AC			2NA 2NC			2NA 2NC		2NA 2NC	
	DC			2NA 2NC			1NA 1NC		1NA 1NC	
Dimensiones										
AC	W×H×D	mm		45×99.6×96.6			55×123.6×129		70×146×153	
AC (Tipo B)				54×84×92			55×123.6×129		70×146×153	
DC				45×99.6×129.5			55×123.6×129		70×146×153	
Operación bobina AC	Cierre		VA	80	80	80	200	200	300	300
	Mantenimiento		VA/W	10/2.5	10/2.5	10/2.5	15/5	15/5	25/10	25/10
Operación bobina DC	Cierre		W	10	10	10	200	200	350	350
	Mantenimiento		W	10	10	10	5	5	8	8

115 - 800 AE

HGC115	HGC130	HGC150	HGC185	HGC225	HGC265	HGC300	HGC400	HGC500	HGC630	HGC800
1,000	1,000	1,000	1,000	1,000	1,000	1,000	1,000	1,000	1,000	1,000
1,000	1,000	1,000	1,000	1,000	1,000	1,000	1,000	1,000	1,000	1,000
8	8	8	8	8	8	8	8	8	8	8
160	180	210	275	315	350	400	500	550	750	900
37/115	40/130	45/150	55/185	75/225	80/265	90/300	125/400	140/500	190/630	220/800
60/115	65/130	75/150	90/185	132/225	147/265	160/300	220/400	250/500	330/630	440/800
59/100	70/120	90/140	110/180	132/200	150/225	200/273	250/300	300/426	330/500	500/720
55/65	75/82	90/120	110/120	132/150	160/173	200/220	250/300	335/360	400/412	500/630
65/50	75/54	90/66	110/78	132/96	160/113	200/141	250/178	275/192	300/213	400/284
100	100	100	100	100	100	100	100	50	50	50
500	500	500	500	500	500	500	500	500	500	500
19/80	22/93	30/125	37/150	45/185	50/200	55/220	75/300	90/350	110/400	160/630
37/75	45/90	55/110	75/150	90/185	102/200	110/220	150/300	175/350	200/400	300/630
3	3	3	3	3	3	3	3	3	3	3
Screw Mounting			Screw Mounting			Screw Mounting			Screw Mounting	
2N02NC			2N02NC			2N02NC			2N02NC	
2N02NC			2N02NC			2N02NC			2N02NC	
103X155X145.1			138X204X174.2			163X243X203			276X314X255.3	

ESPECIFICACIONES TÉCNICAS

CONTACTORES MC

Estrella-Triángulo a 220VAC

Potencia	In	Línea	Delta	Estrella	Térmico
Hp	FLC	(C1)	(C2)	(C3)	TOR
7.5	22	HGC25	HGC25	HGC18	HGT40K
10	32	HGC32	HGC32	HGC25	HGT40K
15	40	HGC40	HGC40	HGC32	HGT40K
20	50	HGC50	HGC50	HGC32	HGT65K
25	70	HGC50	HGC50	HGC40	HGT65K
30	80	HGC75	HGC75	HGC40	HGT100K
40	110	HGC100	HGC100	HGC50	HGT100K
50	130	HGC115	HGC115	HGC65	HGT150K
60	150	HGC130	HGC130	HGC65	HGT150K
75	180	HGC150	HGC150	HGC100	HGT150K
100	260	HGC185	HGC185	HGC115	HGT265K
125	300	HGC225	HGC225	HGC130	HGT265K
150	367	HGC300	HGC300	HGC150	HGT500K
180	434	HGC400	HGC400	HGC225	HGT500K
220	519	HGC400	HGC400	HGC225	HGT500K
350	810	HGC630	HGC630	HGC400	HGT800K

Estrella-Triangulo a 440VAC

Potencia	In	Línea	Delta	Estrella	Térmico
Hp	FLC	(C1)	(C2)	(C3)	TOR
7.5	22	HGC25	HGC25	HGC18	HGT40K
10	32	HGC32	HGC32	HGC25	HGT40K
15	40	HGC40	HGC40	HGC32	HGT40K
20	50	HGC50	HGC50	HGC32	HGT65K
25	70	HGC50	HGC50	HGC40	HGT65K
30	80	HGC75	HGC75	HGC40	HGT100K
40	110	HGC100	HGC100	HGC50	HGT100K
50	130	HGC115	HGC115	HGC65	HGT150K
60	150	HGC130	HGC130	HGC65	HGT150K
75	180	HGC150	HGC150	HGC100	HGT150K
100	260	HGC185	HGC185	HGC115	HGT265K
125	300	HGC225	HGC225	HGC130	HGT265K
150	367	HGC300	HGC300	HGC150	HGT500K
180	434	HGC400	HGC400	HGC225	HGT500K
220	519	HGC400	HGC400	HGC225	HGT500K
350	810	HGC630	HGC630	HGC400	HGT800K

RELÉS TÉRMICOS TOR

CÓDIGO	REFERENCIA	DESCRIPCIÓN	PRECIO UNITARIO
--------	------------	-------------	-----------------

RELÉS TÉRMICOS PARA CONTACTORES HGC

		Rango de Corriente (A)	Para contactores	
HYU0252	HGT18 KA0P90S	0.6 - 0.9	HGC9 ~ 18	\$ 117.200
HYU0253	HGT18 KA1P60S	1.1 - 1.6	HGC9 ~ 18	\$ 117.200
HYU0254	HGT18 KA2P10S	1.5 - 2.1	HGC9 ~ 18	\$ 117.200
HYU0255	HGT18 KA4P20S	2.8 - 4.2	HGC9 ~ 18	\$ 117.200
HYU0256	HGT18 KA0006S	4 - 6	HGC9 ~ 18	\$ 117.200
HYU0257	HGT40 KA0010S	7 - 10	HGC25 ~ 40	\$ 161.600
HYU0258	HGT40 KA0012S	8 - 12	HGC25 ~ 40	\$ 161.600
HYU0259	HGT40 KA0022S	15 - 22	HGC25 ~ 40	\$ 161.600
HYU0260	HGT40 KA0025S	17 - 25	HGC25 ~ 40	\$ 161.600
HYU0261	HGT40 KA0032S	22 - 32	HGC25 ~ 40	\$ 161.600
HYU0262	HGT65 KA0040S	28 - 40	HGC50 ~ 65	\$ 210.900
HYU0263	HGT65 KA0050S	34 - 50	HGC50 ~ 65	\$ 210.900
HYU0264	HGT65 KA0065S	45 - 65	HGC50 ~ 65	\$ 210.900
HYU0265	HGT150 KA0080S	48 - 80	HGC115 ~ 150	\$ 789.500
HYU0266	HGT150 KA0115S	69 - 115	HGC115 ~ 150	\$ 789.500
HYU0267	HGT150 KA0130S	78 - 130	HGC115 ~ 150	\$ 789.500
HYU0268	HGT150 KA0150S	90 - 150	HGC115 ~ 150	\$ 789.500



HGT 18



HGT 40

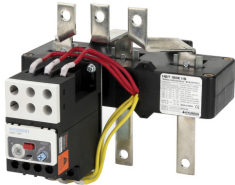

HGT 115-265



* Producto bajo pedido

** Producto última vez en lista de precios o hasta agotar inventarios
NU Producto Nuevo

