



ÍNDICE

Mini interruptores 6K A	8-2
Mini interruptores 10K A	8-3
Accesorios para mininterruptores de 6KA y 10KA	8-4
Interruptores Diferenciales	8-4
Especificaciones técnicas mini interruptores MCB	8-5
Especificaciones técnicas interruptores diferenciales RCB	8-6 · 8-7
Interruptores Fijos hasta 800A caja moldeada MCCB	8-8
Interruptores Regulables hasta 800A caja moldeada MCCB	8-8 · 8-9
Interruptores Fijos Monopolares 80 y 100A caja moldeada MCCB	8-9
Interruptores Magnéticos hasta 200A caja moldeada MCCB	8-9
Accesorios para interruptores caja moldeada MCCB	8-10 · 8-11
Interruptores Regulables 1000A-1600A caja moldeada MCCB	8-12
Especificaciones técnicas interruptores caja moldeada MCCB	8-13 · 8-15
Interruptores abiertos 1000A-3200A ACB HGS	8-16
Especificaciones técnicas interruptores abiertos serie HGS - ACB	8-17
Guardamotores con mando rotatorio hasta 32A y por pulsadores Hasta 80A	8-18
Contactores MC hasta 800A	8-19
Contactores para DC	8-20
Contactores para Condensadores	8-20
Contactores Auxiliares y Accesorios	8-21
Accesorios para contactores	8-21 · 8-22
Especificaciones técnicas contactores MC	8-23 · 8-26
Relés térmicos TOR	8-27

CÓDIGO	REFERENCIA	DESCRIPCIÓN				PRECIO		
MONOPOLARES								
		In (A)	Curva de disparo	IEC/EN60898-1		IEC/EN60947-2		
HYU0544	HGD63M1PMCS0000C00001	1	C	127V=10KA	220V=6KA	127V=15KA	220V=10KA	\$ 28.200
HYU0545	HGD63M1PMCS0000C00002	2						\$ 28.200
HYU0546	HGD63M1PMCS0000C00003	3						\$ 28.200
HYU0547	HGD63M1PMCS0000C00004	4						\$ 18.200
HYU0548	HGD63M1PMCS0000C00006	6						\$ 18.200
HYU0549	HGD63M1PMCS0000C00010	10						\$ 18.200
HYU0550	HGD63M1PMCS0000C00016	16						\$ 18.200
HYU0551	HGD63M1PMCS0000C00020	20						\$ 18.200
HYU0552	HGD63M1PMCS0000C00025	25						\$ 18.200
HYU0553	HGD63M1PMCS0000C00032	32						\$ 18.200
HYU0554	HGD63M1PMCS0000C00040	40						\$ 18.200
HYU0555	HGD63M1PMCS0000C00050	50						\$ 18.200
HYU0556	HGD63M1PMCS0000C00063	63						\$ 18.200
BIPOLARES								
		In (A)	Curva de disparo	IEC/EN60898-1		IEC/EN60947-2		
HYU0557	HGD63M2PMCS0000C00001	1	C	127V=10KA	220V=6KA	127V=15KA	220V=10KA	\$ 54.400
HYU0558	HGD63M2PMCS0000C00002	2						\$ 54.400
HYU0559	HGD63M2PMCS0000C00003	3						\$ 54.400
HYU0560	HGD63M2PMCS0000C00004	4						\$ 54.400
HYU0561	HGD63M2PMCS0000C00006	6						\$ 36.300
HYU0562	HGD63M2PMCS0000C00010	10						\$ 36.300
HYU0563	HGD63M2PMCS0000C00016	16						\$ 36.300
HYU0564	HGD63M2PMCS0000C00020	20						\$ 36.300
HYU0565	HGD63M2PMCS0000C00025	25						\$ 36.300
HYU0566	HGD63M2PMCS0000C00032	32						\$ 36.300
HYU0567	HGD63M2PMCS0000C00040	40						\$ 36.300
HYU0568	HGD63M2PMCS0000C00050	50						\$ 36.300
HYU0569	HGD63M2PMCS0000C00063	63						\$ 36.300
TRIPOLARES								
		In (A)	Curva de disparo	IEC/EN60898-1		IEC/EN60947-2		
HYU0570	HGD63M3PMCS0000C00001	1	C	127V=10KA	220V=6KA	127V=15KA	220V=10KA	\$ 72.500
HYU0571	HGD63M3PMCS0000C00002	2						\$ 72.500
HYU0572	HGD63M3PMCS0000C00003	3						\$ 72.500
HYU0573	HGD63M3PMCS0000C00004	4						\$ 54.500
HYU0574	HGD63M3PMCS0000C00006	6						\$ 54.500
HYU0575	HGD63M3PMCS0000C00010	10						\$ 54.500
HYU0576	HGD63M3PMCS0000C00016	16						\$ 54.500
HYU0577	HGD63M3PMCS0000C00020	20						\$ 54.500
HYU0578	HGD63M3PMCS0000C00025	25						\$ 54.500
HYU0579	HGD63M3PMCS0000C00032	32						\$ 54.500
HYU0580	HGD63M3PMCS0000C00040	40						\$ 54.500
HYU0581	HGD63M3PMCS0000C00050	50						\$ 54.500
HYU0582	HGD63M3PMCS0000C00063	63						\$ 54.500



HGD63M 1 POLOS



HGD63M 2 POLOS



HGD63M 3 POLOS

MINI INTERRUPTORES 10KA

CÓDIGO	REFERENCIA	DESCRIPCIÓN				PRECIO
--------	------------	-------------	--	--	--	--------

MONOPOLARES

		In (A)	Curva de disparo	IEC/EN60898-1		IEC/EN60947-2		
HYU0505	HGD63P1PMCS0000C00001	1						\$ 28.200
HYU0506	HGD63P1PMCS0000C00002	2						\$ 28.200
HYU0507	HGD63P1PMCS0000C00003	3						\$ 28.200
HYU0508	HGD63P1PMCS0000C00004	4						\$ 28.200
HYU0509	HGD63P1PMCS0000C00006	6						\$ 25.100
HYU0510	HGD63P1PMCS0000C00010	10						\$ 25.100
HYU0511	HGD63P1PMCS0000C00016	16	C	127V=15KA	220V=10KA	127V=20KA	220V=15KA	\$ 25.100
HYU0512	HGD63P1PMCS0000C00020	20						\$ 25.100
HYU0513	HGD63P1PMCS0000C00025	25						\$ 25.100
HYU0514	HGD63P1PMCS0000C00032	32						\$ 25.100
HYU0515	HGD63P1PMCS0000C00040	40						\$ 25.100
HYU0516	HGD63P1PMCS0000C00050	50						\$ 25.100
HYU0517	HGD63P1PMCS0000C00063	63						\$ 25.100



HGD63P 1 POLOS

BIPOLARES

		In (A)	Curva de disparo	IEC/EN60898-1		IEC/EN60947-2		
HYU0518	HGD63P2PMCS0000C00001	1						\$ 77.800
HYU0519	HGD63P2PMCS0000C00002	2						\$ 77.800
HYU0520	HGD63P2PMCS0000C00003	3						\$ 77.800
HYU0521	HGD63P2PMCS0000C00004	4						\$ 77.800
HYU0522	HGD63P2PMCS0000C00006	6						\$ 52.300
HYU0523	HGD63P2PMCS0000C00010	10						\$ 52.300
HYU0524	HGD63P2PMCS0000C00016	16	C	127V=15KA	220V=10KA	127V=20KA	220V=15KA	\$ 52.300
HYU0525	HGD63P2PMCS0000C00020	20						\$ 52.300
HYU0526	HGD63P2PMCS0000C00025	25						\$ 52.300
HYU0527	HGD63P2PMCS0000C00032	32						\$ 52.300
HYU0528	HGD63P2PMCS0000C00040	40						\$ 77.800
HYU0529	HGD63P2PMCS0000C00050	50						\$ 77.800
HYU0530	HGD63P2PMCS0000C00063	63						\$ 77.800



HGD63P 2 POLOS

TRIPOLARES

		In (A)	Curva de disparo	IEC/EN60898-1		IEC/EN60947-2		
HYU0531	HGD63P3PMCS0000C00001	1						\$ 83.600
HYU0532	HGD63P3PMCS0000C00002	2						\$ 83.600
HYU0533	HGD63P3PMCS0000C00003	3						\$ 83.600
HYU0534	HGD63P3PMCS0000C00004	4						\$ 83.600
HYU0535	HGD63P3PMCS0000C00006	6						\$ 83.600
HYU0536	HGD63P3PMCS0000C00010	10						\$ 83.600
HYU0537	HGD63P3PMCS0000C00016	16	C	127V=15KA	220V=10KA	127V=20KA	220V=15KA	\$ 83.600
HYU0538	HGD63P3PMCS0000C00020	20						\$ 83.600
HYU0539	HGD63P3PMCS0000C00025	25						\$ 83.600
HYU0540	HGD63P3PMCS0000C00032	32						\$ 83.600
HYU0541	HGD63P3PMCS0000C00040	40						\$ 89.600
HYU0542	HGD63P3PMCS0000C00050	50						\$ 89.600
HYU0543	HGD63P3PMCS0000C00063	63						\$ 89.600



HGD63P 3 POLOS



ACCESORIOS PARA MININTERRUPTORES DE 6KA Y 10KA E INTERRUPTORES DIFERENCIALES

CÓDIGO	REFERENCIA	DESCRIPCIÓN	PRECIO
--------	------------	-------------	--------

ACCESORIOS PARA MININTERRUPTORES DE 6KA Y 10KA

HYU0583	AUX HGD63P	Contacto estado AUX HGD63P COM-NA-1NC HGD63-M/P	\$ 89.300
HYU0584	ALT HGD63P	Contacto falla ALT HGD63P COM-NA-1NC HGD63-M/P	\$ 89.300
HYU0585	SHT HGD63PS2	Bobina de disparo 220VAC SHT HGD63PS2, Para HGD63M/P	\$ 71.900
HYU0586	UVTHGD63PU2	Bobina de mínima tensión 230VAC UVTHGD63PU2, Para HGD63M/P	\$ 104.600
HYU0599	PLD M63 A	Sistema para candado PLD M63 a uso con HGD, candado 8mm	\$ 28.200



HRC63S

INTERRUPTORES DIFERENCIALES HRC Standard Type

		Corriente Nominal In (A)	Corriente residual de operación (mA)	Número de Polos	Tipo	
HYU0587	HRC63S2PG4S0000C00025G	25	30	2P (1P+N)	AC	\$ 127.800
HYU0588	HRC63S2PG4S0000C00040G	40	30	2P (1P+N)	AC	\$ 127.800
HYU0589	HRC63S4PG4S0000C00025G	25	30	4P (3P+N)	AC	\$ 187.500
HYU0590	HRC63S4PG4S0000C00040G	40	30	4P (3P+N)	AC	\$ 187.500
HYU0591	HRC63S4PG4S0000C00063G	63	30	4P (3P+N)	AC	BAJO CONSULTA
HYU0592	HRC1004PG4S0000C00080G	80	30	4P (3P+N)	AC	BAJO CONSULTA
HYU0593	HRC63S2PG4S0000C00025F	25	30	2P (1P+N)	A	BAJO CONSULTA
HYU0594	HRC63S2PG4S0000C00040F	40	30	2P (1P+N)	A	BAJO CONSULTA
HYU0595	HRC63S4PG4S0000C00025F	25	30	4P (3P+N)	A	BAJO CONSULTA
HYU0596	HRC63S4PG4S0000C00040F	40	30	4P (3P+N)	A	BAJO CONSULTA
HYU0597	HRC63S4PG4S0000C00063F	63	30	4P (3P+N)	A	BAJO CONSULTA
HYU0598	HRC100S4PG4S0000C00080F	80	30	4P (3P+N)	A	BAJO CONSULTA

* Producto bajo pedido

** Producto última vez en lista de precios o hasta agotar inventarios

NU Producto Nuevo

ESPECIFICACIONES TÉCNICAS

MINI INTERRUPTORES - MCB

Modelo	HGD-63N, 63 A	HGD-63H, 63 A	HGD-63M, 63 A	HGD-63P, 63 A
Norma de referencia	IEC/EN 60898-1	IEC/EN 60898-1 ; IEC/EN 60947-2	IEC/EN 60898-1, IEC/EN 60947-2	IEC/EN 60898-1, IEC/EN 60947-2
Núm. de polos	1P, 2P, 3P	1P, 2P, 3P	1P, 2P, 3P	1P, 2P, 3P
Intensidad nominal (In)	1, 2, 3, 4, 5, 6, 10, 16, 20, 25, 32, 40, 50, 63 A	1, 2, 3, 4, 5, 6, 10, 16, 20, 25, 32, 40, 50, 63 A	1, 2, 3, 4, 5, 6, 10, 16, 20, 25, 32, 40, 50, 63 A	1, 2, 3, 4, 5, 6, 10, 16, 20, 25, 32, 40, 50, 63 A
Tensión de empleo máx. (Ue)	AC 240/415 V	AC 240/415 V	AC 240/415 V	AC 240/415 V
Frecuencia (F)	50/60 Hz	50/60 Hz	50/60 Hz	50/60 Hz
Poder de corte (Icn)	6 kA (Ics=100 % Icn)	10 kA (Ics=100 % Icn)	6 kA (Ics=100 % Icn)	10 kA (Ics=75 % Icn)
Característica de disparo (curva)	(5-10) In - Curva C	(5-10) In - Curva C	(5-10) In - Curva C	(5-10) In - Curva C
Tensión asignada de aislamiento (Ui)	500 V	500 V	500 V	500 V
Tensión nominal de resistencia a los impulsos (Uimp)	4 kV	4 kV	4 kV	4 kV
Resistencia dieléctrica	2.5 kV	2.5 kV	2.5 kV	2.5 kV
Endurancia Eléctrica	10.000	10.000	10.000	10.000
Mecánica (núm. de maniobras)	20.000	20.000	20.000	20.000
Temperatura de funcionamiento	-5 °C a + 55 °C	-5 °C a + 55 °C	-5 °C a + 55 °C	-5 °C a + 55 °C
Humedad	95 % RH	95 % RH	95 % RH	95 % RH
Clase de limitación de energía	3	3	3	3
Tamaño del terminal (máx)	35 mm ²	35 mm ²	35 mm ²	35 mm ²
Par de apriete máximo	2 N·m	2 N·m	2 N·m	2 N·m
Vibración	3 g	3 g	3 g	3 g
Grado de protección IP	IP20	IP20	IP20	IP20
Indicador visual de posición de contacto	Rojo-ON, Verde-OFF	Rojo-ON, Verde-OFF	Rojo-ON, Verde-OFF	Rojo-ON, Verde-OFF
Peso neto por polo	0.125 kg	0.125 kg	0.125 kg	0.125 kg
Dimensiones (Alto x Profundo x Ancho) por polo	87.5 x 71.7 x 17.7 mm	87.5 x 71.7 x 17.7 mm	87.5 x 71.7 x 17.7 mm	87.5 x 71.7 x 17.7 mm
Montaje	Riel DIN	Riel DIN	Riel DIN	Riel DIN
Posición de instalación	Vertical/Horizontal	Vertical/Horizontal	Vertical/Horizontal	Vertical/Horizontal
Carcasa y cubierta	Material termoplástico moldeado, ignífugo	Material termoplástico moldeado, ignífugo	Material termoplástico moldeado, ignífugo	Material termoplástico moldeado, ignífugo
Tipo conexión peine lado superior/inferior	Tipo Pin/Horquilla (Inferior)	Tipo Pin/Horquilla (Inferior)	Tipo Pin/Horquilla (Inferior)	Tipo Pin/Horquilla (Inferior)
AUX/ALT/SHT/UVT/OVT	Sí	Sí	Sí	Sí

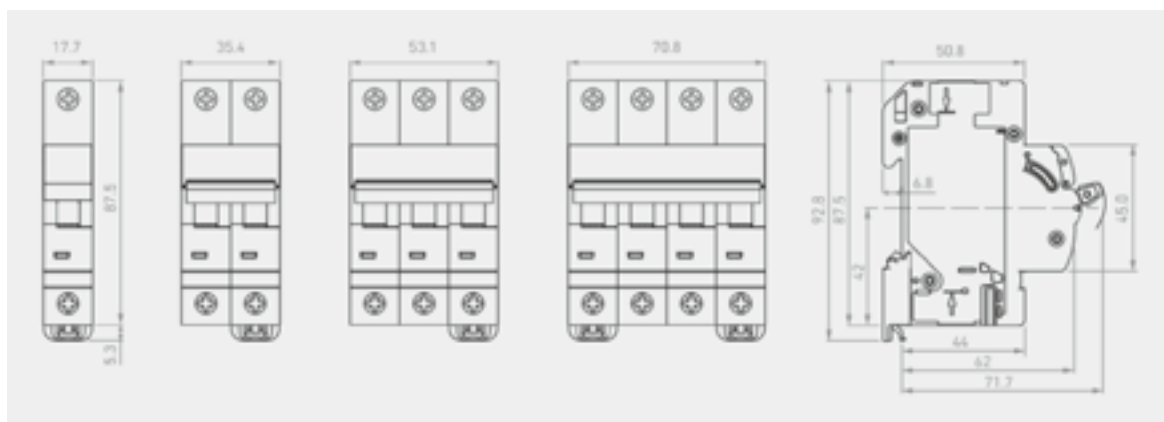





ESPECIFICACIONES TÉCNICAS

INTERRUPTORES DIFERENCIALES - RCB







Modelo	HRC63	HRC100, 100 AF
Norma de referencia	IEC/EN 61008-1	IEC/EN 61008-1
Núm. de polos	2P (N + 1P), 4P (N + 3P)	2P (N + 1P), 4P (N + 3P)
Intensidad nominal (In)	25, 40, 63 A	80 A
Tensión de empleo (Ue)	AC 240/415 V	AC 240/415 V
Frecuencia (F)	50/60 Hz	50/60 Hz
Poder de corte (Inc)	10 kA	10 kA
Sensibilidad (IΔc)	30 mA	30 mA
Poder asignado de cierre (Lm)	630 A o 10 In, el que sea mayor	630 A o 10 In, el que sea mayor
Carac. en función de la presencia fugas con componente en cc	Tipo 'A' y tipo 'AC'	Tipo 'A' y tipo 'AC'
Tiempo de disparo	1 IΔn < 300 ms, 5 IΔn < 40 ms	1 IΔn < 300 ms, 5 IΔn < 40 ms
Tensión de aislamiento (Ui)	500 V	500 V
Tensión nominal de resistencia impulsos (Uimp)	4 kV	4 kV
Resistencia dieléctrica	2.5 kV	2.5 kV
Endurancia Eléctrica / Mecánica de maniobras) Mínimo	10,000/20,000	10,000/20,000
Temperatura de funcionamiento	-25 °C a + 55 °C	-25 °C a + 55 °C
Humedad	95 % RH	95 % RH
Tamaño del terminal (máx.)	35 mm ²	50 mm ²
Par de apriete máximo	2 N·m	2.5 N·m
Vibración	3 g	3 g
Grado de protección IP	IP20	IP20
Indicador visual de posición contacto	Rojo-ON, Verde-OFF	Rojo-ON, Verde-OFF
Peso neto en kg	0.215 kg (en 2P) ; 0.335 kg (en 4P)	0.230 kg (en 2P) ; 0.404 kg (en 4P)
Dimensiones (Alto x Profundo Ancho) por polo en mm	87.5 x 71.7 x 35.9 mm (en 2P) ; 87.5 x 71.7 x 72.0 mm (en 4P)	88.2 x 71.7 x 35.9 mm (en 2P) ; 88.2 x 71.7 x 72.0 mm (en 4P)
Montaje	Clip 35 mm x 7.5 mm carril DIN	Clip 35 mm x 7.5 mm carril DIN
Posición de instalación	Vertical/Horizontal	Vertical/Horizontal
Carcasa y cubierta	Material termoplástico moldeado, ignífugo	Material termoplástico moldeado, ignífugo
Tipo conexión peine	Tipo Pin/Horquilla	Tipo Pin/Horquilla
Contactos auxiliares	Sí	No

Efectos de la corriente en el cuerpo Humano

1-10 mA	10 mA	20-30 mA	70-100 mA	500 mA
				
1 ~ 9 mA	Sensación de cosquilleo			
10 mA	Contracción de Músculos, la persona tiende a mantener el conductor			
20 ~ 30 mA	Contracción de músculos más fuerte, puede causar parálisis respiratoria			
70 ~ 100 mA	Fibrilación cardíaca, situación muy peligrosa, daños irreversibles			
500 mA	Ataque cardíaco fulminante, muerte			

ESPECIFICACIONES TÉCNICAS

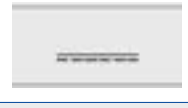
INTERRUPTORES DIFERENCIALES - RCB

Tipos de diferenciales	AC	A	F (SI) Super inmunizado	B
CARACTERÍSTICAS	<p>Detecta solo corriente residual alterna. Tiene nula efectividad ante armónicos y otros.</p> <p>Los semiconductores generan corrientes de fuga que no son detectadas por los de clase AC</p>	<p>Detecta corriente residual y pulsante que ocurre repentinamente o aumenta lentamente en magnitud.</p>	<p>Detecta corriente residual alterna hasta 1kHz y pulsante, así como frecuencias mezcladas por fugas en la red eléctrica</p>	<p>Detecta corriente residual alterna hasta 1kHz y pulsante y pura continua. Se utilizan para detectar corrientes de fuga de DC.</p>
TIPO DE CARGA	<p>Cargas resistivas, inductivas y capacitivas sin componentes electrónicos.</p> <p>Ejemplos: Iluminación halógena, hornos, calentadores, Estufas eléctricas.</p>	<p>Cargas con componentes electrónicos.</p> <p>Ejemplos: Aire acondicionado, Iluminación led, computadores</p>	<p>Equipos con control de frecuencia o rectificación de AC</p> <p>Ejemplos: Variadores de frecuencia, Aire acondicionado con variador de frecuencia, UPS</p>	<p>Equipos especiales. Ejemplos: Cargadores de vehículos eléctricos, Inversores y cargadores de baterías trifásicos</p>
FORMA DE ONDA				
	SI	SI	SI	SI
		SI	SI	SI
		SI	SI	SI
		SI	SI	SI
			SI	SI
				SI
				SI

INTERRUPTORES CAJA MOLDEADA MCCB



HGM100-800
Ics=100% Icu



HGM400

CÓDIGO	REFERENCIA	DESCRIPCIÓN				PRECIO	
		Rango de Corriente (A)		Capacidad de Ruptura (KA)			Dimensiones A x L x P (mm)
		In (A)	Ir (A)	220V AC	440V AC		
INTERRUPTORES FIJOS HGM 100/800... DE 16 A 800A							
HYU0295	HGM100 E3PT4S0000C 00016	16	-	35	16	75 x 130 x 68	\$ 251.600
HYU0296	HGM100 E3PT4S0000C 00020	20	-	35	16	75 x 130 x 68	\$ 251.600
HYU0297	HGM100 E3PT4S0000C 00025	25	-	35	16	75 x 130 x 68	\$ 259.500
HYU0298	HGM100 E3PT4S0000C 00032	32	-	35	16	75 x 130 x 68	\$ 259.500
HYU0299	HGM100 E3PT4S0000C 00040	40	-	35	16	75 x 130 x 68	\$ 259.500
HYU0300	HGM100 E3PT4S0000C 00050	50	-	35	16	75 x 130 x 68	\$ 259.500
HYU0301	HGM100 E3PT4S0000C 00063	63	-	35	16	75 x 130 x 68	\$ 259.500
HYU0302	HGM100 E3PT4S0000C 00080	80	-	35	16	75 x 130 x 68	\$ 272.200
HYU0303	HGM100 E3PT4S0000C 00100	100	-	35	16	75 x 130 x 68	\$ 286.300
HYU0389	HGM250 E3PT4S0000C 00125	125	-	50	20	105 x 165 x 68	\$ 538.500
HYU0390	HGM250 E3PT4S0000C 00160	160	-	50	20	105 x 165 x 68	\$ 547.100
HYU0391	HGM250 E3PT4S0000C 00200	200	-	50	20	105 x 165 x 68	\$ 584.900
HYU0392	HGM250 E3PT4S0000C 00250	250	-	50	20	105 x 165 x 68	\$ 605.800
HYU0393	HGM400 E3PT4S0000C 00300	300	-	50	38	140 x 257 x 110	\$ 1.220.800
HYU0394	HGM400 E3PT4S0000C 00400	400	-	50	38	140 x 257 x 110	\$ 1.260.900
HYU0395	HGM630 E3PT4S0000C 00500	500	-	50	38	210 x 280 x 110	\$ 1.940.400
HYU0396	HGM630 E3PT4S0000C 00630	630	-	50	38	210 x 280 x 110	\$ 2.004.000
HYU0397	HGM800 S3PT4S0000C 00800	800	-	75	50	210 x 280 x 110	\$ 2.765.100
INTERRUPTORES REGULABLES HGM 100 S3PT4S...F DE 16 A 800A, 50KA/220VAC							
		Rango de Corriente (A)		Capacidad de Ruptura (KA)		Dimensiones A x L x P (mm)	
		In (A)	Ir (A)	220V AC	440V AC		
HYU0304	HGM100 S3PT4S0000C 00016F	16	13 ~ 16	50	20	75 x 130 x 68	\$ 317.900
HYU0305	HGM100 S3PT4S0000C 00020F	20	16 ~ 20	50	20	75 x 130 x 68	\$ 317.900
HYU0306	HGM100 S3PT4S0000C 00025F	25	20 ~ 25	50	20	75 x 130 x 68	\$ 328.100
HYU0307	HGM100 S3PT4S0000C 00032F	32	26 ~ 32	50	20	75 x 130 x 68	\$ 328.100
HYU0308	HGM100 S3PT4S0000C 00040F	40	32 ~ 40	50	20	75 x 130 x 68	\$ 328.100
HYU0309	HGM100 S3PT4S0000C 00050F	50	40 ~ 50	50	20	75 x 130 x 68	\$ 328.100
HYU0310	HGM100 S3PT4S0000C 00063F	63	51 ~ 63	50	20	75 x 130 x 68	\$ 328.100
HYU0311	HGM100 S3PT4S0000C 00080F	80	64 ~ 80	50	20	75 x 130 x 68	\$ 328.100
HYU0312	HGM100 S3PT4S0000C 00100F	100	80 ~ 100	50	20	75 x 130 x 68	\$ 356.900
HYU0313	HGM250 E3PT4S0000C 00125F	125	100 ~ 125	50	20	105 x 165 x 68	\$ 652.500
HYU0314	HGM250 E3PT4S0000C 00160F	160	128 ~ 160	50	20	105 x 165 x 68	\$ 663.900
HYU0315	HGM250 E3PT4S0000C 00200F	200	160 ~ 200	50	20	105 x 165 x 68	\$ 714.100
HYU0316	HGM250 E3PT4S0000C 00250F	250	200 ~ 250	50	20	105 x 165 x 68	\$ 734.900
HYU0317	HGM400 E3PT4S0000C 00300F	300	189 ~ 300	50	38	140 x 257 x 110	\$ 1.488.900
HYU0318	HGM400 E3PT4S0000C 00400F	400	252 ~ 400	50	38	140 x 257 x 110	\$ 1.528.100
HYU0319	HGM630 E3PT4S0000C 00500F	500	315 ~ 500	50	38	210 x 280 x 110	\$ 2.419.400
HYU0320	HGM630 E3PT4S0000C 00630F	630	397 ~ 630	50	38	210 x 280 x 110	\$ 2.502.900
HYU0336	HGM800 H3PT4S0000C 00800F	800	504 ~ 800	100	70	210 x 280 x 110	\$ 3.445.600

INTERRUPTORES CAJA MOLDEADA MCCB



CÓDIGO	REFERENCIA	DESCRIPCIÓN	PRECIO
--------	------------	-------------	--------

INTERRUPTORES REGULABLES HGM125H3PT4S....F DE 16 a 250A, 85KA/220VAC Y 400 a 800A,100KA/220VAC

		Rango de Corriente (A)		Capacidad de Ruptura (KA)		Dimensiones A x L x P (mm)		
		In (A)	Ir (A)	220V AC	440V AC			
*	HYU0321	HGM125 H3PT4S0000C 00016F	16	13 ~ 16	85	38	90 x 155 x 68	BAJO CONSULTA
*	HYU0322	HGM125 H3PT4S0000C 00020F	20	16 ~ 20	85	38	90 x 155 x 68	BAJO CONSULTA
*	HYU0323	HGM125 H3PT4S0000C 00025F	25	20 ~ 25	85	38	90 x 155 x 68	BAJO CONSULTA
*	HYU0324	HGM125 H3PT4S0000C 00032F	32	26 ~ 32	85	38	90 x 155 x 68	BAJO CONSULTA
*	HYU0325	HGM125 H3PT4S0000C 00040F	40	32 ~ 40	85	38	90 x 155 x 68	BAJO CONSULTA
*	HYU0326	HGM125 H3PT4S0000C 00050F	50	40 ~ 50	85	38	90 x 155 x 68	BAJO CONSULTA
*	HYU0327	HGM125 H3PT4S0000C 00063F	63	51 ~ 63	85	38	90 x 155 x 68	BAJO CONSULTA
*	HYU0328	HGM125 H3PT4S0000C 00080F	80	64 ~ 80	85	38	90 x 155 x 68	BAJO CONSULTA
*	HYU0329	HGM125 H3PT4S0000C 00100F	100	80 ~ 100	85	38	90 x 155 x 68	BAJO CONSULTA
*	HYU0330	HGM125 H3PT4S0000C 00125F	125	100 ~ 125	85	38	90 x 155 x 68	BAJO CONSULTA
*	HYU0331	HGM250 H3PT4S0000C 00160F	160	128 ~ 160	85	38	105 x 165 x 68	BAJO CONSULTA
*	HYU0332	HGM250 H3PT4S0000C 00200F	200	160 ~ 200	85	38	105 x 165 x 68	BAJO CONSULTA
*	HYU0333	HGM250 H3PT4S0000C 00250F	250	200 ~ 250	85	38	105 x 165 x 68	BAJO CONSULTA
*	HYU0334	HGM400 H3PT4S0000C 00400F	400	252 ~ 400	100	70	140 x 257 x 110	BAJO CONSULTA
*	HYU0335	HGM630 H3PT4S0000C 00630F	630	397 ~ 630	100	70	210 x 280 x 110	BAJO CONSULTA
	HYU0336	HGM800 H3PT4S0000C 00800F	800	504 ~ 800	100	70	210 x 280 x 110	\$ 3.445.600

FRAME	ANCHO	ALTO	PROF
HGM100	75	130	68
HGM125	90	155	68
HGM250	105	165	68
HGM400	140	257	110
HGM630	210	280	110
HGM800	210	280	110

INTERRUPTORES FIJOS MONOPOLARES DE 80 Y 100 A, 35 KA

		Rango de Corriente (A)	Capacidad de Ruptura (KA)		Polos	Dimensiones A x L x P (mm)		
			In (A)	220V AC				440V AC
NU	HYU0616	HGM100E2PT4S0000C00080	80	35	16	2	50 x 130 x 68	\$ 286.300
NU	HYU0617	HGM100E2PT4S0000C00100	100	35	16	2	50 x 130 x 68	\$ 286.300

INTERRUPTORES MAGNETICOS.... DE 63 A 200A

		Rango de Corriente (A)	Capacidad de Ruptura (KA)		Dimensiones A x L x P (mm)		
			In (A)	220V AC			440V AC
NU	HYU0618	HGM100E3PMOS0000C00063B	63	35	16	75 x 130 x 68	BAJO CONSULTA
NU	HYU0619	HGM100E3PMOS0000C00080B	80	35	16	75 x 130 x 68	BAJO CONSULTA
NU	HYU0620	HGM100E3PMOS0000C00100B	100	35	16	75 x 130 x 68	BAJO CONSULTA
NU	HYU0621	HGM250E3PMOS0000C00125B	125	50	20	105 x 165 x 68	BAJO CONSULTA
NU	HYU0622	HGM250E3PMOS0000C00160B	160	50	20	105 x 165 x 68	BAJO CONSULTA
NU	HYU0623	HGM250E3PMOS0000C00200B	200	50	20	105 x 165 x 68	BAJO CONSULTA

* Producto bajo pedido

** Producto última vez en lista de precios o hasta agotar inventarios

NU Producto Nuevo



ACCESORIOS PARA INTERRUPTORES CAJA MOLDEADA MCCB



TFH

CÓDIGO	REFERENCIA	DESCRIPCIÓN	PRECIO
MANIJAS			
HYU0337	TFH 10GM	Manija a puerta para HGM100	\$ 219.900
HYU0338	TFH 12GM	Manija a puerta para HGM125	\$ 219.900
HYU0339	TFH 25GM	Manija a puerta para HGM250	\$ 227.700
HYU0340	TFH 40GM	Manija a puerta para HGM400	\$ 578.800
HYU0341	TFH 80GM	Manija a puerta para HGM630,800	\$ 594.200
HYU0377	THA48GM	Maneta o lengüeta auxiliar para HGM400-800	\$ 56.400
HYU0342	TFG 10GMU	Manija para montaje sobre interruptor para HGM100	\$ 140.900
HYU0343	TFG 12GMU	Manija para montaje sobre interruptor para HGM125	\$ 140.900
HYU0344	TFG 25GMU	Manija para montaje sobre interruptor para HGM250	\$ 155.600
HYU0345	TFG 40GMU	Manija para montaje sobre interruptor para HGM400	\$ 473.100
HYU0346	TFG 80GMU	Manija para montaje sobre interruptor para HGM630,800	\$ 540.200
HYU0375	PLD 10GM	Accesorio de manija (a puerta o sobre int.) Para candado usar con HGM100 ~ 250 , diámetro candado 5mm soporta hasta 3 candados	\$ 64.000
HYU0376	PLD 40GM	Accesorio de manija (a puerta o sobre int.) Para candado usar con HGM400 ~ 800 , diámetro candado 5mm soporta hasta 3 candados	\$ 64.000

CONTACTOS AUXILIARES			
HYU0347	AUX 10GMC1	Contacto auxiliar para HGM100-250	\$ 44.100
HYU0348	AUX 40GMC1	Contacto auxiliar para HGM400-800	\$ 73.200
HYU0497	ALT10GMR1	Contacto aux. Falla (alarma) ALT10GMR1 para HGM100-250	\$ 71.700
HYU0498	ALT40GML1	Contacto aux. Falla (alarma) ALT40GML1 para HGM400-800	\$ 83.700

JUEGOS DE TERMINALES Y CUBIERTAS			
* HYU0378	CTB10 GM 3S50	Juego de terminales 3P menor 50A 2.5-16MM HGM100	BAJO CONSULTA
* HYU0379	CTB10 GM 3S100	Juego de terminales 3P mayor 50A 16-50MM HGM100	BAJO CONSULTA
* HYU0380	CTB12 GM 3S	Juego de terminales 3 polos 2.5-70MM HGM125	BAJO CONSULTA
* HYU0381	CTB25 GM 3S	Juego de terminales 3 polos 50-180MM HGM160,250	BAJO CONSULTA
* HYU0382	CTB40 GM 3S	Juego de terminales 3 polos 60-240MM HGM400	BAJO CONSULTA
* HYU0383	CTB80 GM 3S	Juego de terminales 3 polos 60-185MM HGM630,800	BAJO CONSULTA
HYU0384	TCF10 GM S3	Cubierta de terminales IP40 corta 3P HGM100	\$ 24.100
HYU0385	TCF12 GM S3	Cubierta de terminales IP40 corta 3P HGM125	\$ 24.900
HYU0386	TCF25 GM S3	Cubierta de terminales IP40 corta 3P HGM160,250	\$ 27.900
HYU0387	TCF40 GM S3	Cubierta de terminales IP40 corta 3P HGM400	\$ 49.400
HYU0388	TCF80 GM S3	Cubierta de terminales IP40 corta 3P HGM630,800	\$ 54.300

* Producto bajo pedido

** Producto última vez en lista de precios o hasta agotar inventarios

NU Producto Nuevo



ACCESORIOS PARA INTERRUPTORES CAJA MOLDEADA MCCB



CÓDIGO	REFERENCIA	DESCRIPCIÓN	PRECIO
--------	------------	-------------	--------

BOBINAS DE MÍNIMA Y DISPARO

		TIPO DE BOBINA	VOLTAJE	PARA INTERRUPTOR		
*	HYU0349	UVT10 GM DC24V	Mínima Tensión	24V DC	HGM100-250	BAJO CONSULTA
*	HYU0350	UVT40 GM DC24V	Mínima Tensión	24V DC	HGM400-800	BAJO CONSULTA
*	HYU0351	UVT10 GM AC100-120V	Mínima Tensión	100-120V AC	HGM100-250	BAJO CONSULTA
*	HYU0352	UVT40 GM AC100-120V	Mínima Tensión	100-120V AC	HGM400-800	BAJO CONSULTA
	HYU0353	UVT10 GM AC200-230V	Mínima Tensión	200-230V AC	HGM100-250	\$ 273.500
	HYU0354	UVT40 GM AC200-230V	Mínima Tensión	200-230V AC	HGM400-800	\$ 273.500
*	HYU0355	SHT10 GM DC24V	Disparo o Shunt	24V DC	HGM100-250	BAJO CONSULTA
*	HYU0356	SHT40 GM DC24V	Disparo o Shunt	24V DC	HGM400-800	BAJO CONSULTA
*	HYU0357	SHT10 GM AC100-120V	Disparo o Shunt	100-120V AC	HGM100-250	BAJO CONSULTA
*	HYU0358	SHT40 GM AC100-120V	Disparo o Shunt	100-120V AC	HGM400-800	BAJO CONSULTA
	HYU0359	SHT10 GM AC200-250V	Disparo o Shunt	200-230V AC	HGM100-250	\$ 93.600
	HYU0360	SHT40 GM AC200-230V	Disparo o Shunt	200-230V AC	HGM400-800	\$ 212.400



ENCLAVAMIENTO MECÁNICO (PARA USO SIN MOTORIZADO)

			PARA INTERRUPTOR	
	HYU0361	MIF 10GM 3	HGM100	\$ 109.000
	HYU0362	MIF 12GM 3	HGM125	\$ 109.000
	HYU0363	MIF 25GM 3	HGM250	\$ 125.800
	HYU0364	MIF 40GM 3	HGM400	\$ 196.000
	HYU0365	MIF 80GM 3	HGM630,800	\$ 227.500



OPERADOR MOTORIZADO

		VOLTAJE	PARA INTERRUPTOR		
*	HYU0366	MOT25 GM DC24V	24V DC	HGM250	BAJO CONSULTA
*	HYU0367	MOT40 GM DC24V	24V DC	HGM400	BAJO CONSULTA
*	HYU0368	MOT80 GM DC24V	24V DC	HGM630,800	BAJO CONSULTA
*	HYU0369	MOT25 GM AC/DC110V	110V AC/DC	HGM250	BAJO CONSULTA
*	HYU0370	MOT40 GM AC/DC110V	110V AC/DC	HGM400	BAJO CONSULTA
*	HYU0371	MOT80 GM AC/DC110V	110V AC/DC	HGM630,800	BAJO CONSULTA
	HYU0372	MOT25 GM AC/DC240V	240V AC/DC	HGM250	\$ 2.024.400
	HYU0373	MOT40 GM AC/DC240V	240V AC/DC	HGM400	\$ 2.907.900
	HYU0374	MOT80 GM AC/DC240V	240V AC/DC	HGM630,800	\$ 3.271.000

* Producto bajo pedido

** Producto última vez en lista de precios o hasta agotar inventarios

NU Producto Nuevo



INTERRUPTORES CAJA MOLDEADA MCCB

CÓDIGO	REFERENCIA	DESCRIPCIÓN	PRECIO
--------	------------	-------------	--------

INTERRUPTORES CAJA MOLDEADA DE 1000A HASTA 1600A, ELECTRÓNICOS, LSI

		Rango de Corriente (A)			Capacidad de Ruptura (KA)		Dimensiones A x L x P (mm)	
		In (A)	"I _r (A) Min."	"I _r (A) Max"	220V AC	440V AC		
HYU0600	HGM1000S3PENBS-0000C01000A	1000	400	1000	100KA	45KA	210x370x124	\$ 12.063.000
HYU0601	HGM1250S3PENBS-0000C01250A	1250	500	1250	100KA	45KA	210x370x124	\$ 14.600.000
HYU0602	HGM1600S3PENBS-0000C01600	1600	640	1600	100KA	45KA	210x370x155	BAJO CONSULTA

ACCESORIOS

HYU0603	AUX120GMSC2	Contacto AUX. estado AUX120GMSC2 Para HGM1000-1600, 2NA-2NC	BAJO CONSULTA
HYU0606	SHT120GM-SAC200-230V	Bobina SHT120GMSAC200-230V de disparo 220V Para HGM1000-1600	BAJO CONSULTA
HYU0607	UVT120GM-SAC200-230V	Bobina UVT120GMSAC200-230V De minima 220V Para HGM1000-1600	BAJO CONSULTA
HYU0609	TFH120GMS3	Manija a puerta TFH120GMS3 Para HGM1000-1600	BAJO CONSULTA

* Producto bajo pedido

** Producto última vez en lista de precios o hasta agotar inventarios

NU Producto Nuevo



HGM1000S3PENBS0000C0XXXXA

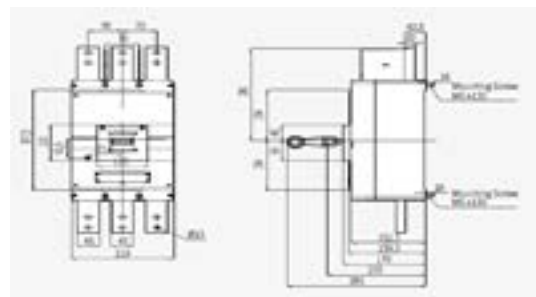

HGM1000S3PENBS0000C0XXXXA

ESPECIFICACIONES TÉCNICAS

INTERRUPTORES CAJA MOLDEADA MCCB



Modelo		HGM100			HGM250			
Marco	(AF)		100			250		
Polos	(P)		3			3		
Corriente nominal, a 40°	(A)		20, 25, 32, 40, 50, 63, 75, 80, 100			100, 125, 150, 160, 175, 200, 225, 250		
Poder de corte [Icu] (kA rms)	Código para pedido		E	S	H	E	S	H
	AC660/690 V		2.5	5	7.5	7.5	8	8
	AC480/500 V		7.5	10	14	14	20	26
	AC440/460 V		16	20	26	20	26	38
	AC380/415 V		16	20	26	20	26	38
	AC220/240 V		35	50	50	50	65	85
	DC250 V (2P)		5	10	15	10	15	20
Capac. de corte del servicio [Ics = 100% Icu]			100	100	75	100	100	100
Endurancia (maniobras)	Mecánica		30000			30000		
	Eléctrica		10000			10000		
Protección Magnética	Fija		(1.0) x In			(1.0) x In		
	Ajustable		(0.8 - 0.9 - 1.0) x In			(0.8 - 0.9 - 1.0) x In		
	Instantáneo [INST]		16 - 32 A: 400 A, 40 - 100 A: 10 x In			10 x In		
Accesorios								
Internos	Contacto auxiliar	AUX	si	si	si	si	si	si
	Señalización alarma	ALT	si	si	si	si	si	si
	Bobina de emisión	SHT	si	si	si	si	si	si
	Bobina de mínima tensión	UVT	si	si	si	si	si	si
Externos	Manija Sobre interruptor	TFG	si	si	si	si	si	si
	Manija a puerta	TFH	si	si	si	si	si	si
	Mando motorizado	MOT	si	si	si	si	si	si
	Enclavamiento mecánico	MIF	si	si	si	si	si	si
	Bloqueo candado	PLD	si	si	si	si	si	si
	Bloque prensacables	CTB	si	si	si	si	si	si
	Cubrebornes	TCF	si	si	si	si	si	si
	Separador de fases	TQQ	si	si	si	si	si	si
Pletina espaciadora	TBB				si	si	si	
Instalación y dimensiones								
Conexión	Conexión frontal		Terminal de tornillo			Terminal de tornillo/pala		
Dimensiones (mm)	a (2/3/4P)		75			105		
	b		130			165		
	c		68			68		
Peso (kg)	2/3/4P		0.6/0.8/1.0			1.1/1.3/1.7		

ESPECIFICACIONES TÉCNICAS

INTERRUPTORES CAJA MOLDEADA MCCB

Modelo		HGM400			HGM630			HGM800		
Marco	(AF)	400			630			800		
Polos	(P)	3			3			3		
Corriente nominal, a 40°	(A)	250, 300, 350, 400			500, 630			700, 800		
Poder de corte [Icu] (kA rms)	Código para pedido	E	S	H	E	S	H	S	H	
	AC660/690 V	5	8	10	5	8	10	8	10	
	AC480/500 V	18	35	50	25	45	50	45	50	
	AC440/460 V	38	50	70	38	50	70	50	70	
	AC380/415 V	45	65	85	45	65	85	65	85	
	AC220/240 V	50	75	100	50	75	100	75	100	
	DC250 V (2P)	20	25	40	20	25	40	25	40	
Capac. de corte del servicio [Ics = 100% Icu]		100	100	100	100	100	100	100	100	
Endurancia (maniobras)	Mecánica	30000			30000			30000		
	Eléctrica	10000			10000			10000		
Protección Magnética	Fija	(1.0) x In			(1.0) x In			(1.0) x In		
	Ajustable	(0.63 - 0.8 - 1.0) x In			(0.63 - 0.8 - 1.0) x In			(0.63 - 0.8 - 1.0) x In		
	Instantáneo [INST]	10 x In			10 x In			10 x In		
Accesorios										
Internos	Contacto auxiliar	AUX	si	si	si	si	si	si	si	si
	Señalización alarma	ALT	si	si	si	si	si	si	si	si
	Bobina de emisión	SHT	si	si	si	si	si	si	si	si
	Bobina de mínima tensión	UVT	si	si	si	si	si	si	si	si
Externos	Manija Sobre interruptor	TFG	si	si	si	si	si	si	si	si
	Manija a puerta	TFH	si	si	si	si	si	si	si	si
	Mando motorizado	MOT	si	si	si	si	si	si	si	si
	Enclavamiento mecánico	MIF	si	si	si	si	si	si	si	si
	Bloqueo candado	PLD	si	si	si	si	si	si	si	si
	Bloque prensacables	CTB	si	si	si	si	si	si	si	si
	Cubrebornes	TCF	si	si	si	si	si	si	si	si
	Separador de fases	TQQ	si	si	si	si	si	si	si	si
Pletina espaciadora	TBB	si	si	si	si	si	si	si	si	
Instalación y dimensiones										
Conexión	Conexión frontal	Terminal de tornillo			Terminal de tornillo/pala			Terminal de tornillo/pala		
Dimensiones (mm)	a (2/3/4P)	140			210			210		
	b	257			280			280		
	c	110			110			110		
Peso (kg)	2/3/4P	4/4.5/5.4			8.7/9.5/12.5			8.7/9.5/12.5		

INTERRUPTORES CAJA MOLDEADA MCCB

| Padlock plate (PLD) |



AUX 80NE R2
ALT 80NE R1

2 contactor
1 contacto

Bloqueo para hasta 3 candados
Ampliación de maneta
enclavamiento mecánico

PLD 120NE
THA 120NE

Parece que no hay maneta a puerta
incluir motorizado
Bobina de apertura

| Extension handle (THA) |

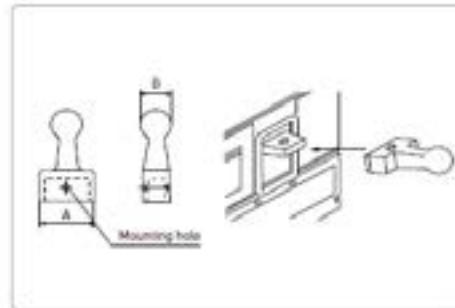

Model		HGM1000	HGM1250	HGM1400	
Frame	(kV)	1,000	1,250	1,400	
Pole	(P)	3,4*	3,4*	3	
Rated current, at 40°C, Electric	(A)	1,000	1,000/1,250	1,400	
Rated short-circuit breaking capacity [Icu] (kA rms)	Recognition code for order	0	5	0	
	AC440/660 V	20	20	20	
	AC690/900 V	35	35	35	
	AC440/660 V	40	45	45	
	AC380/415 V	70	70	70	
Service breaking capacity [Ics] (kA rms)	AC440/660 V	100	100	100	
	AC690/900 V	17.5	17.5	17.5	
	AC440/660 V	17.5	17.5	24.0	
	AC440/660 V	22.5	22.5	31.5	
	AC380/415 V	45	45	50	
AC220/240 V	90	90	70		
Rated short-time withstand current [Icw] (kA) 1s		15	16	12.5	
Endurance (Durability)	Mechanical	10,000	10,000	10,000	
	Electrical	2,000	1,000	2,000	
Trip Device		●	●	●	
Electrics	Long time (I _{tr} , I ₂)	0.4-0.5-0.6-0.7-0.8-0.9-0.95-1.0s	0.4-0.5-0.6-0.7-0.8-0.9-0.95-1.0s	0.4-0.5-0.6-0.7-0.8-0.9-0.95-1.0s	
	Short time (STO, I ₂)	2-3-4-5-6-7-8-10s	2-3-4-5-6-7-8-10s	2-3-4-5-6-7-8-10s	
	Instantaneous (IMT, I ₂)	2-3-4-5-6-7-8-10s	2-3-4-5-6-7-8-10s	2-3-4-5-6-7-8-10s	
Accessory					
Internal	Auxiliary switch	AUX	●	●	
	Alarm switch	ALT	●	●	
	Shunt trip	SHT	●	●	
	Under-voltage trip	UVT	●	●	
	Rotary handle	Extended THA	●	●	
	Motor operator	MOT	●	●	
	Mechanical interlock	MF	●	●	
	Lock Mechanism with Key		●	●	
External	Draw-out	-	-	-	
	Plug-in	TPM(LINE/LOAD)	-	-	-
		TPM(LINE) Draw	-	-	-
	Cage terminal block	CTB	●	●	
	Insulation terminal cover	ICP	●	●	
	Insulation barrier	IBS	●	●	
	Terminal extensions	TBE	Standard	Standard	Standard
Installation and dimensions					
Connection/Installation	Front connection	Terminal busbar	Terminal busbar	Terminal busbar	
	Rear connection	-	-	-	
	Plug-in	-	-	-	
Dimensions (mm)	a (Depth)	210/240	210/240	210	
	b	370	370	370	
	c	134	124	105	

INTERRUPTORES ABIERTOS ACB HGS



HGS

Ics=100% Icu



HGS

GPR-LA



- Protección sobrecarga (L/S/VG)
- Auto alimentación
- Contacto de salida individual continuo
- Registro de fallos (hasta 754) y armónicos (4 ciclos, verificación vía comunicación)
- Comunicación MODBUS: se puede utilizar conexión a tierra externa ZCT

CÓDIGO	REFERENCIA	DESCRIPCIÓN	PRECIO
--------	------------	-------------	--------

INTERRUPTORES ABIERTOS HGS MONTAJE FIJO DE 800-3200A, UNIDAD DE PROTECCIÓN GPR-LA (L/S/I/G) CON COMUNICACIÓN MODBUS

		Rango de Corriente (A)		Capacidad de Ruptura (KA)		FRAME	
		In (A)	Ir (A)	220V AC	500V AC		
* HYU0398	HGS 08A3HMOCOS061H	800	320-800	65	65	A	BAJO CONSULTA
HYU0399	HGS 10A3HMOCOS061J	1000	400-1000	65	65	A	\$ 12.160.300
HYU0400	HGS 12A3HMOCOS061K	1250	500-1250	65	65	A	\$ 12.316.200
HYU0401	HGS16A3HMOCOS061L	1600	640-1600	65	65	A	\$ 12.500.000
HYU0402	HGS 20B3HMOCOS061M	2000	800-2000	85	85	B	\$ 15.937.800
HYU0403	HGS 25B3HMOCOS061N	2500	1000-2500	85	85	B	\$ 18.464.100
HYU0404	HGS 32B3HMOCOS061P	3200	1280-3200	85	85	B	\$ 19.355.400

ENCLAVAMIENTO MECÁNICO PARA INTERRUPTORES DE MONTAJE FIJO

		PARA INTERRUPTOR: HGN/HGS	
HYU0428	HGNS FWB1A	PARA DOS INTERRUPTORES FRAME A	\$ 3.815.000
HYU0430	HGNS FWB1B	PARA DOS INTERRUPTORES FRAME B	\$ 4.099.100

BOBINAS DE ACCIONAMIENTO Y MOTORIZADO PARA INTERRUPTORES DE MONTAJE FIJO

		ELEMENTO	VOLTAJE	PARA INTERRUPTOR	
HYU0442	HGNS M2U	Motorizado	220V AC/DC	HGN / HGS	\$ 1.570.000
HYU0443	HGNS C2	Bobina Cierre	220V AC/DC	HGN / HGS	\$ 409.000
HYU0444	HGNS S2	Bobina Apertura / Disparo	220V AC/DC	HGN / HGS	\$ 409.000

* Producto bajo pedido

** Producto última vez en lista de precios o hasta agotar inventarios

NU Producto Nuevo

CONTACTOS AUXILIARES DE ESTADO

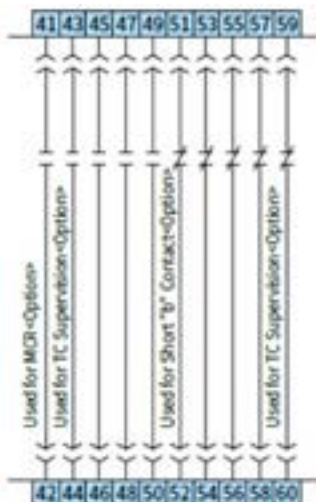

CONTACTOS AUXILIARES DE DISPARO O FALLA

Puntos de conexión	Contactos de falla
22 21	Sobrecarga
22 23	Predisparo (Sobrecarga)
22 24	Cortocircuito e instantáneo
22 26	Falla a tierra



ESPECIFICACIONES TÉCNICAS

INTERRUPTORES ABIERTOS SERIE HGS - ACB



Marco Tipo		A	B	A
Corriente nominal [In max]	Temperatura basada en 40 °C A	06 : 630	20 : 2,000	06 : 630
		08 : 800	25 : 2,500	08 : 800
		10 : 1,000	32 : 3,200	10 : 1,000
		12 : 1,250		12 : 1,250
		16 : 1,600		16 : 1,600
				20 : 2,000
Tensión nominal de empleo [Ue]	V	690	690	690
Tensión nominal de aislamiento [Ui]	V	1	1	1
Frecuencia	Hz	50/60	50/60	50/60
Número de Polos	P	3, 4	3, 4	3, 4
Rango de regulación de intensidad (... x In max)	A	0.4 ~ 1.0	0.4 ~ 1.0	0.4 ~ 1.0
Intensidad nominal del neutro (N) (... %xIn) A	A	100%	100%	100%
Poder de corte [Icu] [kA sym]				
IEC 60947- Categoría	690/600/550 V	50	70 1) (KS : 65)	65
"B"	AC 500/480/460 V KA	65	85	85
KS C 4620	415/380/230/220 V	65	85	85
Poder de corte de servicio [Ics] ...%xIcu		100%	100%	100%
Poder de cierre [Icm] [kA pico]				
IEC 60947- Categoría	690/600/550 V	105	154	143
"B"	AC 500/480/460 V KA	143	187	187
KS C 4620	415/380/230/220 V	143	187	187
Intensidad de corta duración admisible [Icw] (Sin Inst)				
1 Seg.		50	70	65
2 Seg.	KA	35	65	42
3 Seg.		28	50	35
Tensión asignada soportada al impulso [Uimp]	Kv	12	12	12
Tiempo máximo de corte	mS	40 3)	40 3)	40 3)
Tiempo de cierre				
Tiempo de rearme motor (seg) max.		10	10	10
Tiempo de cierre (ms) max.		80	80	80
Duración de vida(Ciclos)				
Mecánica	Sin mantenimiento	20,000	20,000	20,000
	Con mantenimiento	30,000	30,000	30,000
Eléctrica	Sin mantenimiento	5,000	5,000	5,000
	Con mantenimiento	10,000	10,000	10,000
Peso				
3 Polos	Tipo extraible	63	87	63
	Tipo fijo Kg	34	44	34
4 Polos	Tipo extraible	74	103	74
	Tipo fijo	44	55	44
Dimensiones (WxHxD)				
Internos	Tipo extraible	328x460x368.4	399x460x368.4	328x460x368.4
	Tipo fijo mm	337.4x404.4x295.8	408.4x404.4x295.8	337.4x404.4x295.8
	Tipo extraible	413x460x368.4	514x460x368.4	413x460x368.4
	Tipo fijo	422.4x404.4x295.8	523.4x404.4x295.8	422.4x404.4x295.8

Notas

- 1) 70 kA certificado en DEKRA
- 2) 4,000 AF
- 3) En caso de MCR y ajustes anulados, el INST es 50 ms.

GUARDAMOTORES CON MANDO ROTATORIO Y POR PULSADORES

CÓDIGO	REFERENCIA	DESCRIPCIÓN	PRECIO
--------	------------	-------------	--------

GUARDAMOTORES SERIE MMS32R CON MANDO ROTATORIO

			Corriente		Capacidad de ruptura (Icu)		
			In (A)	Ir (A)	220V	440V	
NU	HYU0624	MMS32 R1P00	1	0.63 - 1	100	100	BAJO CONSULTA
NU	HYU0625	MMS32 R01P6	1.6	1 - 1.6	100	100	BAJO CONSULTA
NU	HYU0626	MMS32 R02P5	2.5	1.6 - 2.5	100	100	BAJO CONSULTA
NU	HYU0627	MMS32 R0004	4	2.5 - 4	100	100	BAJO CONSULTA
NU	HYU0628	MMS32 R06P3	6.3	4 - 6.3	100	50	BAJO CONSULTA
NU	HYU0629	MMS32 R0010	10	6-10	100	15	BAJO CONSULTA
NU	HYU0630	MMS32 R0014	14	9-14	100	8	BAJO CONSULTA
NU	HYU0631	MMS32 R0018	18	13 - 18	100	8	BAJO CONSULTA
NU	HYU0632	MMS32 R0023	23	17 - 23	50	6	BAJO CONSULTA
NU	HYU0633	MMS32 R0025	25	20 - 25	50	6	BAJO CONSULTA
NU	HYU0634	MMS32 R0032	32	24 - 32	50	6	BAJO CONSULTA

GUARDAMOTORES SERIE MMS32/80 K CON MANDO POR PULSADORES

			Rango de Corriente (A)	Capacidad de ruptura (Icu)		
				220V	440V	
	HYU0274	MMS32 K1P00	0.63 - 1	100	100	\$ 162.100
	HYU0275	MMS32 K01P6	1 - 1.6	100	100	\$ 162.100
	HYU0276	MMS32 K02P5	1.6 - 2.5	100	100	\$ 162.100
	HYU0277	MMS32 K0004	2.5 - 4	100	100	\$ 162.100
	HYU0278	MMS32 K06P3	4 - 6.3	100	50	\$ 162.100
	HYU0279	MMS32 K0010	6 - 10	100	15	\$ 162.100
	HYU0280	MMS32 K0014	9 - 14	100	8	\$ 162.100
	HYU0281	MMS32 K0018	13 - 18	100	8	\$ 162.100
	HYU0282	MMS32 K0023	17 - 23	50	6	\$ 162.100
	HYU0283	MMS32 K0025	20 - 25	50	6	\$ 162.100
	HYU0284	MMS32 K0032	24 - 32	50	6	\$ 162.100
	HYU0285	MMS80 K0040	25 - 40	100	50	\$ 477.000
	HYU0286	MMS80 K0063	40 - 63	100	50	\$ 517.500
	HYU0287	MMS80 K0080	56 - 80	100	10	\$ 526.400

ACCESORIOS

		Para Guardamotor MMS32K	
HYU0288	MMS32 KAUXT11	Contacto Auxiliar de estado de 1NA + 1 NC, montaje Frontal para MMS32K	\$ 32.900
HYU0289	MMS32 KAUXS11	Contacto Auxiliar de estado de 1NA + 1 NC, montaje Lateral para MMS32K	\$ 42.300
HYU0290	MMS80 KAUXS11	Contacto Auxiliar de estado de 1NA + 1 NC, montaje Lateral para MMS80K	\$ 67.300
HYU0292	MS32 KAXT1010	Contacto Auxiliar de falla (1 NA) y estado (1NA), montaje lateral, para MMS32K	\$ 77.600

* Producto bajo pedido

** Producto última vez en lista de precios o hasta agotar inventarios

NU Producto Nuevo

CÓDIGO	REFERENCIA	DESCRIPCIÓN				PRECIO
--------	------------	-------------	--	--	--	--------

CONTACTORES AC HGC9-100

		Corriente Max de Operación 220/440V (A)		Potencia Max. De Operación en AC3 (kW)	Tensión de operación de la bobina (V)	Contactos Auxiliares	
		AC1	AC3	220V		440V	
HYU0098	HGC9 11NS A110	25	9	2,5	AC110	1NA+1NC	\$ 115.200
HYU0099	HGC9 11NS A220	25	9	2,5	AC220	1NA+1NC	\$ 115.200
HYU0102	HGC12 11NS A110	30	12	3,5	AC110	1NA+1NC	\$ 126.900
HYU0103	HGC12 11NS A220	30	12	3,5	AC220	1NA+1NC	\$ 126.900
HYU0106	HGC18 11NS A110	40	18	4,5	AC110	1NA+1NC	\$ 145.500
HYU0107	HGC18 11NS A220	40	18	4,5	AC220	1NA+1NC	\$ 145.500
HYU0110	HGC25 11NS A110	45	25	5,5	AC110	1NA+1NC	\$ 182.000
HYU0111	HGC25 11NS A220	45	25	5,5	AC220	1NA+1NC	\$ 182.000
HYU0114	HGC32 11NS A110	55	32	7,5	AC110	1NA+1NC	\$ 192.700
HYU0115	HGC32 11NS A220	55	32	7,5	AC220	1NA+1NC	\$ 192.700
HYU0118	HGC40 11NS A110	60	40	11	AC110	1NA+1NC	\$ 245.600
HYU0119	HGC40 11NS A220	60	40	11	AC220	1NA+1NC	\$ 245.600
HYU0122	HGC50 22NS A110	70	50	15	AC110	2NA+2NC	\$ 375.800
HYU0123	HGC50 22NS A220	70	50	15	AC220	2NA+2NC	\$ 375.800
HYU0126	HGC65 22NS A110	85	65	18,5	AC110	2NA+2NC	\$ 440.300
HYU0127	HGC65 22NS A220	85	65	18,5	AC220	2NA+2NC	\$ 440.300
HYU0130	HGC85 22NS A110	125	85	25	AC110	2NA+2NC	\$ 550.100
HYU0131	HGC85 22NS A220	125	85	25	AC220	2NA+2NC	\$ 550.100
HYU0134	HGC100 22NS A110	145	100	30	AC110	2NA+2NC	\$ 666.800
HYU0135	HGC100 22NS A220	145	100	30	AC220	2NA+2NC	\$ 666.800



HGC25



HGC130- 300



HGC400- 800

CONTACTORES AC HGC130-300

		Corriente Max de Operación 220/440V (A)		Potencia Max. De Operación en AC3 (kW)	Tensión de operación de la bobina (V)	Contactos Auxiliares	
		AC1	AC3	220V		440V	
HYU0138	HGC130 22NS F220	180	130	40	AC/DC 100 ~ 240	2NA+2NC	\$ 1.127.300
HYU0141	HGC150 22NS F220	210	150	45	AC/DC 100 ~ 240	2NA+2NC	\$ 1.257.900
HYU0143	HGC185 22NS F220	275	185	55	AC/DC 100 ~ 240	2NA+2NC	\$ 1.714.900
HYU0145	HGC225 22NS F220	315	225	75	AC/DC 100 ~ 240	2NA+2NC	\$ 1.850.000
HYU0147	HGC265 22NS F220	350	265	80	AC/DC 100 ~ 240	2NA+2NC	\$ 2.212.500
HYU0149	HGC300 22NS F220	400	300	90	AC/DC 100 ~ 240	2NA+2NC	\$ 2.932.600

CONTACTORES AC HGC400-800

		Corriente Max de Operación 220/440V (A)		Potencia Max. De Operación en AC3 (kW)	Tensión de operación de la bobina (V)	Contactos Auxiliares	
		AC1	AC3	220V		440V	
HYU0151	HGC400 22NS F220	500	400	125	AC/DC 100 ~ 240	2NA+2NC	\$ 3.779.100
HYU0153	HGC500 22NS F220	550	500	140	AC/DC 100 ~ 240	2NA+2NC	\$ 5.000.900
HYU0155	HGC630 22NS F220	750	630	190	AC/DC 220	2NA+2NC	\$ 10.459.900
HYU0157	HGC800 22NS F220	900	800	220	AC/DC 220	2NA+2NC	\$ 11.943.200



CONTACTORES MC

CÓDIGO	REFERENCIA	DESCRIPCIÓN	PRECIO
--------	------------	-------------	--------

CONTACTORES DC HGC9-65

		Corriente Max de Operación 220/440V (A)		Potencia Max. De Operación en AC3 (kW)		Tensión de operación de la bobina (V)		
		AC1	AC3	220V	440V			
		HYU0159	HGC9 11NS D024	25	9			2,5
*	HYU0162	HGC12 11NS D024	30	12	3,5	5,5	DC24	BAJO CONSULTA
	HYU0165	HGC18 11NS D024	40	18	4,5	7,5	DC24	\$ 209.900
*	HYU0168	HGC25 11NS D024	45	25	5,5	11	DC24	BAJO CONSULTA
*	HYU0171	HGC32 11NS D024	55	32	7,5	15	DC24	BAJO CONSULTA
*	HYU0174	HGC40 11NS D024	60	40	11	18,5	DC24	BAJO CONSULTA
*	HYU0177	HGC50 21NS D024	70	50	15	22	DC24	BAJO CONSULTA
*	HYU0180	HGC65 21NS D024	85	65	18,5	30	DC24	BAJO CONSULTA



HGC25

CONTACTORES PARA CONDENSADORES, CON RESISTENCIAS DE PRECARGA

		Potencia Reactiva kVAR		Tensión de operación de la bobina (V)	Contactos Auxiliares	
		220V AC	440V AC			
HYU0198	HGC12C 22NS A110	6,7	12,0	110V AC	2NA+2NC	\$ 300.600
HYU0199	HGC12C 22NS A220	6,7	12,0	220 VAC	2NA+2NC	\$ 300.600
HYU0201	HGC18C 22NS A110	8,5	16,7	110V AC	2NA+2NC	\$ 317.300
HYU0202	HGC18C 22NS A220	8,5	16,7	220 VAC	2NA+2NC	\$ 317.300
HYU0204	HGC25C 22NS A110	10,0	20,0	110V AC	2NA+2NC	\$ 359.100
HYU0205	HGC25C 22NS A220	10,0	20,0	220 VAC	2NA+2NC	\$ 359.100
HYU0207	HGC40C 22NS A110	15,0	29,0	110V AC	2NA+2NC	\$ 500.300
HYU0208	HGC40C 22NS A220	15,0	29,0	220 VAC	2NA+2NC	\$ 500.300
HYU0210	HGC50C 22NS A110	19,0	40,0	110V AC	2NA+2NC	\$ 564.100
HYU0211	HGC50C 22NS A220	19,0	40,0	220 VAC	2NA+2NC	\$ 564.100



HGC 12C-50C

* Producto bajo pedido

** Producto última vez en lista de precios o hasta agotar inventarios

NU Producto Nuevo

CONTACTORES AUXILIARES Y ACCESORIOS

CÓDIGO	REFERENCIA	DESCRIPCIÓN	PRECIO
--------	------------	-------------	--------

CONTACTORES AUXILIARES

		Tensión de operación de la bobina (V)	Contactos Auxiliares	
HYU0183	HGR 22NS A024	24V AC	2NA+2NC	\$ 136.200
HYU0184	HGR 22NS A110	110 VAC	2NA+2NC	\$ 116.100
HYU0185	HGR 22NS A220	220V AC	2NA+2NC	\$ 116.100
HYU0187	HGR 31NS A024	24V AC	3NA+1NC	\$ 136.200
HYU0188	HGR 31NS A110	110V AC	3NA+1NC	\$ 116.100
HYU0189	HGR 31NS A220	220 VAC	3NA+1NC	\$ 116.100
HYU0192	HGR 40NS A110	110V AC	4NA	\$ 116.100
HYU0193	HGR 40NS A220	220V AC	4NA	\$ 116.100
HYU0195	HGR 22PS D024	24V DC	2NA+2NC	\$ 236.800
HYU0196	HGR 31PS D024	24V DC	3NA+1NC	\$ 236.800
HYU0197	HGR 40PS D024	24V DC	4NA	\$ 236.800



HGR

BLOQUES DE CONTACTOS AUXILIARES

		Tipo de montaje	Para contactor	Contactos Auxiliares	
HYU0213	HG CTB 11NS	Frontal	HGC9 ~ 100 & HGR	1NA+1NC	\$ 40.700
HYU0215	HG CTB 22NS	Frontal	HGC9 ~ 100 & HGR	2NA+2NC	\$ 66.200
HYU0218	HGC SB40 11NS	Lateral	HGC9 ~ 40	1NA+1NC	\$ 30.000
HYU0219	HGC SB800 11NS	Lateral	HGC115 ~ 800	1NA+1NC	\$ 78.300

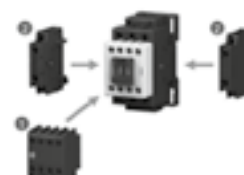

1) Contacto auxiliar (frontal)
2) Contacto auxiliar (lateral)

HG

ENCLAVAMIENTO MECÁNICO PARA CONTACTORES

		Para contactor	
HYU0220	HGC IU40	HGC9 ~ 40	\$ 56.800
HYU0221	HGC IU100	HGC50 ~ 100	\$ 60.100
HYU0222	HGC IU265	HGC115 ~ 265	\$ 63.500
HYU0223	HGC IU800	HGC300 ~ 800	\$ 450.000



HGC IU



CÓDIGO	REFERENCIA	DESCRIPCIÓN	PRECIO
--------	------------	-------------	--------

BOBINAS PARA CONTACTORES HGC

		Tensión de operación de la bobina (V)	Aplica a:		
*	HYU0485	HGC OL18 A024	24V AC	HGC9 ~ 18	BAJO CONSULTA
*	HYU0486	HGC OL18 A110	110V AC	HGC9 ~ 18	BAJO CONSULTA
*	HYU0487	HGC OL18 A220	220V AC	HGC9 ~ 18	BAJO CONSULTA
*	HYU0488	HGC OL18 A440	440V AC	HGC9 ~ 18	BAJO CONSULTA
*	HYU0224	HGC OL40 A024	24V AC	HGC25 ~ 40	BAJO CONSULTA
	HYU0225	HGC OL40 A110	110V AC	HGC25 ~ 40	\$ 56.200
	HYU0226	HGC OL40 A220	220V AC	HGC25 ~ 40	\$ 56.200
*	HYU0227	HGC OL40 A440	440V AC	HGC25 ~ 40	BAJO CONSULTA
*	HYU0228	HGC OL65 A024	24V AC	HGC50 ~ 65	BAJO CONSULTA
	HYU0229	HGC OL65 A110	110V AC	HGC50 ~ 65	\$ 66.000
	HYU0230	HGC OL65 A220	220V AC	HGC50 ~ 65	\$ 66.000
*	HYU0231	HGC OL65 A440	440V AC	HGC50 ~ 65	BAJO CONSULTA
*	HYU0232	HGC OL100 A024	24V AC	HGC75 ~ 100	BAJO CONSULTA
	HYU0233	HGC OL100 A110	110V AC	HGC75 ~ 100	\$ 80.700
	HYU0234	HGC OL100 A220	220V AC	HGC75 ~ 100	\$ 80.700
*	HYU0235	HGC OL100 A440	440V AC	HGC75 ~ 100	BAJO CONSULTA
	HYU0236	HGC OL150 F220	220V AC	HGC115 ~ 150	\$ 375.400
*	HYU0237	HGC OL150 F440	440V AC	HGC115 ~ 150	BAJO CONSULTA
	HYU0238	HGC OL265 F220	220V AC	HGC185 ~ 265	\$ 581.000
*	HYU0239	HGC OL265 F440	440V AC	HGC185 ~ 265	BAJO CONSULTA
**	HYU0240	HGC OL500 F220	220V AC	HGC300 ~ 500	\$ 839.500
*	HYU0241	HGC OL500 F440	440V AC	HGC300 ~ 500	BAJO CONSULTA
	HYU0615	HGC COL800 F220	220V AC/DC	HGC630 ~ 800	\$ 839.500
	HYU0242	HGC OL40 D024	24V DC	HGC25 ~ 40	BAJO CONSULTA
*	HYU0243	HGC OL40 D048	48V DC	HGC25 ~ 40	BAJO CONSULTA
*	HYU0244	HGC OL40 D110	110V DC	HGC25 ~ 40	BAJO CONSULTA
*	HYU0245	HGC OL65 D024	24V DC	HGC50 ~ 65	BAJO CONSULTA
*	HYU0246	HGC OL65 D048	48V DC	HGC50 ~ 65	BAJO CONSULTA
*	HYU0247	HGC OL65 D110	110V DC	HGC50 ~ 65	BAJO CONSULTA

* Producto bajo pedido

** Producto última vez en lista de precios o hasta agotar inventarios

NU Producto Nuevo

Certificaciones de Contactores:

- CB Certification (KTC) : IEC 60947-4-1
- CE Mark
- CCC Certification
- Vessel Certification : LR, ABS, KR, BV, DNV GL, NK, RINA.



MEDIDAS

Tamaño AC	Ancho (mm)	Alto (mm)	Profundo (mm)
HGC9 ~ 18	45	94,2	91,2
HGC25 ~ 40	45	99,6	96,6
HGC50 ~ 65	55	123,6	129
HGC85 ~ 100	70	146	153
HGC130 ~ 150	103	155	145,1
HGC185 ~ 265	138	204	174,2
HGC300 ~ 500	163	243	203
HGC630 ~ 800	276	314	255,3



HGC OL18-100



HGC115- 800
Cambio de Bobina sin
uso de herramienta

ESPECIFICACIONES TÉCNICAS

CONTACTORES MC



Modelo				HGC9	HGC12	HGC18
Norma IEC 60947-4						
Tensión de aislamiento [Ui] V				800	800	800
Tensión nominal de empleo [Ue] V				690	690	690
Tensión nominal impulsional [Uimp] kV				6	6	6
Corriente nominal Ith (AC1) A				25	30	40
AC3	200 ~ 240 V	kW/A		2.5/9	3.5/12	4.5/18
	380 ~ 440 V			4/9	5.5/12	7.5/18
	500 ~ 550 V			4/7	7.5/12	8.5/13
	660 ~ 690 V			4/6	7.5/9	7.5/9
	1,000 V		-	-	-	
	Vida útil	Eléctrica	x10,000	250	250	250
Mecánica		x10,000	1500	1500	1,500	
AC4	200 ~ 240 V	kW/A		1.5/8	2.2/11	3.7/16
	380 ~ 440 V			2.2/6	4/9	4/11
	Vida útil eléctrica	x10,000	3	3	3	
Método de instalación				Tornillo y Carril DIN		
Contactos auxiliares						
Estándar	AC			1NA 1NC o 2NA 2NC		
	AC (Tipo B)			1NA		
	DC			1NA 1NC o 2NA 2NC		
Adicional	AC			2NA 2NC		
	DC			2NA 2NC		
Dimensiones						
AC	W×H×D	mm		45×94.2×91.1		
AC (Tipo B)				45×75×86		
DC				45×94.2×124		
Operación bobina AC	Cierre		VA	80	80	80
	Mantenimiento		VA/W	10/2.5	10/2.5	10/2.5
Operación bobina DC	Cierre		W	10	10	10
	Mantenimiento		W	10	10	10

ESPECIFICACIONES TÉCNICAS

CONTACTORES MC

Modelo				HGC25	HGC32	HGC40	HGC50	HGC65	HGC85	HGC100
Norma IEC 60947-4										
Tensión de aislamiento [Ui] V				800	800	800	1,000	1,000	1,000	1,000
Tensión nominal de empleo [Ue] V				690	690	690	690	690	690	690
Tensión nominal impulsional [Uimp] kV				6	6	6	8	8	8	8
Corriente nominal Ith (AC1) A				45	55	60	70	85	125	145
AC3	200 ~ 240 V	kW/A		5.5/25	7.5/32	11/40	15/50	18.5/65	25/85	30/100
	380 ~ 440 V			11/25	15/32	18.5/40	22/50	30/65	45/85	55/100
	500 ~ 550 V			15/22	18.5/28	22/32	30/43	33/60	50/75	55/85
	660 ~ 690 V			15/17	18.5/20	22/23	30/28	33/35	45/45	50/65
	1,000 V			-	-	-	-	-	-	-
	Vida útil	Eléctrica	x10,000	250	200	200	200	200	200	200
	Mecánica	x10,000	1,500	1,500	1,500	1,500	1,500	1,000	1,000	
AC4	200 ~ 240 V	kW/A		3.7/18	4.5/22	5.5/25	7.5/35	11/50	15/65	17/72
	380 ~ 440 V			5.5/13	7.5/17	11/24	15/32	22/47	30/62	33/68
	Vida útil eléctrica		x10,000	3	3	3	3	3	3	3
Método de instalación				Tornillo y Carril DIN			Tornillo y Carril DIN		Tornillo y Carril DIN	
Contactos auxiliares										
Estándar	AC			1NA 1NC o 2NA 2NC			2NA 2NC		2NA 2NC	
	AC (Tipo B)			1NA			1NA		1NA	
	DC			1NA 1NC o 2NA 2NC			2NA 1NC		2NA 1NC	
Adicional	AC			2NA 2NC			2NA 2NC		2NA 2NC	
	DC			2NA 2NC			1NA 1NC		1NA 1NC	
Dimensiones										
AC	W×H×D	mm		45×99.6×96.6			55×123.6×129		70×146×153	
AC (Tipo B)				54×84×92			55×123.6×129		70×146×153	
DC				45×99.6×129.5			55×123.6×129		70×146×153	
Operación bobina AC	Cierre		VA	80	80	80	200	200	300	300
	Mantenimiento		VA/W	10/2.5	10/2.5	10/2.5	15/5	15/5	25/10	25/10
Operación bobina DC	Cierre		W	10	10	10	200	200	350	350
	Mantenimiento		W	10	10	10	5	5	8	8

ESPECIFICACIONES TÉCNICAS

CONTACTORES MC



115 - 800 AE										
HGC115	HGC130	HGC150	HGC185	HGC225	HGC265	HGC300	HGC400	HGC500	HGC630	HGC800
1,000	1,000	1,000	1,000	1,000	1,000	1,000	1,000	1,000	1,000	1,000
1,000	1,000	1,000	1,000	1,000	1,000	1,000	1,000	1,000	1,000	1,000
8	8	8	8	8	8	8	8	8	8	8
160	180	210	275	315	350	400	500	550	750	900
37/115	40/130	45/150	55/185	75/225	80/265	90/300	125/400	140/500	190/630	220/800
60/115	65/130	75/150	90/185	132/225	147/265	160/300	220/400	250/500	330/630	440/800
59/100	70/120	90/140	110/180	132/200	150/225	200/273	250/300	300/426	330/500	500/720
55/65	75/82	90/120	110/120	132/150	160/173	200/220	250/300	335/360	400/412	500/630
65/50	75/54	90/66	110/78	132/96	160/113	200/141	250/178	275/192	300/213	400/284
100	100	100	100	100	100	100	100	50	50	50
500	500	500	500	500	500	500	500	500	500	500
19/80	22/93	30/125	37/150	45/185	50/200	55/220	75/300	90/350	110/400	160/630
37/75	45/90	55/110	75/150	90/185	102/200	110/220	150/300	175/350	200/400	300/630
3	3	3	3	3	3	3	3	3	3	3
Screw Mounting			Screw Mounting			Screw Mounting			Screw Mounting	
2N02NC			2N02NC			2N02NC			2N02NC	
2N02NC			2N02NC			2N02NC			2N02NC	
103X155X145.1			138X204X174.2			163X243X203			276X314X255.3	

Estrella-Triángulo a 220VAC

Potencia	In	Línea	Delta	Estrella	Térmico
Hp	FLC	(C1)	(C2)	(C3)	TOR
7.5	22	HGC25	HGC25	HGC18	HGT40K
10	32	HGC32	HGC32	HGC25	HGT40K
15	40	HGC40	HGC40	HGC32	HGT40K
20	50	HGC50	HGC50	HGC32	HGT65K
25	70	HGC50	HGC50	HGC40	HGT65K
30	80	HGC75	HGC75	HGC40	HGT100K
40	110	HGC100	HGC100	HGC50	HGT100K
50	130	HGC115	HGC115	HGC65	HGT150K
60	150	HGC130	HGC130	HGC65	HGT150K
75	180	HGC150	HGC150	HGC100	HGT150K
100	260	HGC185	HGC185	HGC115	HGT265K
125	300	HGC225	HGC225	HGC130	HGT265K
150	367	HGC300	HGC300	HGC150	HGT500K
180	434	HGC400	HGC400	HGC225	HGT500K
220	519	HGC400	HGC400	HGC225	HGT500K
350	810	HGC630	HGC630	HGC400	HGT800K

Estrella-Triángulo a 440VAC

Potencia	In	Línea	Delta	Estrella	Térmico
Hp	FLC	(C1)	(C2)	(C3)	TOR
7.5	22	HGC25	HGC25	HGC18	HGT40K
10	32	HGC32	HGC32	HGC25	HGT40K
15	40	HGC40	HGC40	HGC32	HGT40K
20	50	HGC50	HGC50	HGC32	HGT65K
25	70	HGC50	HGC50	HGC40	HGT65K
30	80	HGC75	HGC75	HGC40	HGT100K
40	110	HGC100	HGC100	HGC50	HGT100K
50	130	HGC115	HGC115	HGC65	HGT150K
60	150	HGC130	HGC130	HGC65	HGT150K
75	180	HGC150	HGC150	HGC100	HGT150K
100	260	HGC185	HGC185	HGC115	HGT265K
125	300	HGC225	HGC225	HGC130	HGT265K
150	367	HGC300	HGC300	HGC150	HGT500K
180	434	HGC400	HGC400	HGC225	HGT500K
220	519	HGC400	HGC400	HGC225	HGT500K
350	810	HGC630	HGC630	HGC400	HGT800K

RELÉS TÉRMICOS TOR



CÓDIGO	REFERENCIA	DESCRIPCIÓN	PRECIO
--------	------------	-------------	--------

RELÉS TÉRMICOS PARA CONTACTORES HGC				
		Rango de Corriente (A)	Para contactores	
	HYU0252	HGT18 KA0P90S	0.6 - 0.9	HGC9 ~ 18 \$ 117.200
	HYU0253	HGT18 KA1P60S	1.1 - 1.6	HGC9 ~ 18 \$ 117.200
	HYU0254	HGT18 KA2P10S	1.5 - 2.1	HGC9 ~ 18 \$ 117.200
	HYU0255	HGT18 KA4P20S	2.8 - 4.2	HGC9 ~ 18 \$ 117.200
	HYU0256	HGT18 KA0006S	4 - 6	HGC9 ~ 18 \$ 117.200
NU	HYU0635	HGT18 KA0008S	5, 6 - 8	HGC9 ~ 18 BAJO CONSULTA
NU	HYU0636	HGT18 KA0009S	6 - 9	HGC9 ~ 18 BAJO CONSULTA
NU	HYU0637	HGT18 KA0012S	8 - 12	HGC9 ~ 18 BAJO CONSULTA
NU	HYU0638	HGT18 KA0018S	12-18	HGC9 ~ 18 BAJO CONSULTA
	HYU0259	HGT40 KA0022S	15 - 22	HGC25 ~ 40 \$ 161.600
	HYU0260	HGT40 KA0025S	17 - 25	HGC25 ~ 40 \$ 161.600
	HYU0261	HGT40 KA0032S	22 - 32	HGC25 ~ 40 \$ 161.600
NU	HYU0639	HGT40 KA0040S	28 - 40	HGC25 ~ 40 BAJO CONSULTA
	HYU0263	HGT65 KA0050S	34 - 50	HGC50 ~ 65 \$ 210.900
	HYU0264	HGT65 KA0065S	45 - 65	HGC50 ~ 65 \$ 210.900
NU		HGT100 KA0075S	52-75	HGC85 ~ 100 BAJO CONSULTA
NU		HGT100KA0085S	59-85	HGC85 ~ 100 BAJO CONSULTA
NU		HGT100KA00100S	70-100	HGC85 ~ 100 BAJO CONSULTA
	HYU0266	HGT150 KA0115S	69 - 115	HGC115 ~ 150 \$ 789.500
	HYU0267	HGT150 KA0130S	78 - 130	HGC115 ~ 150 \$ 789.500
	HYU0268	HGT150 KA0150S	90 - 150	HGC115 ~ 150 \$ 789.500



HGT 18



HGT 40

* Producto bajo pedido

** Producto última vez en lista de precios o hasta agotar inventarios

NU Producto Nuevo



